



# JORISIDE

C O M P O N E N T S

Portfolio proizvoda

## Metalni profili

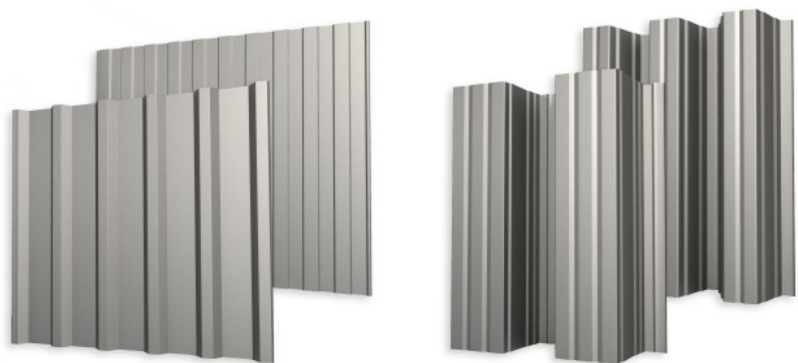

Zidni profili  
Krovni profili  
Profili betonskih obloga - profil 58  
Visoki profili - ravni krovovi  
Obloge  
Kasete  
Plank profili

strana 2 - 10

## Sendvič paneli



Krovni paneli  
Zidni paneli

strana 11 - 21

## Dodaci



Dodaci za zaptivanje i izolaciju  
Zvetlarnici  
Završni profili  
Sistemi za odvod kišnice

strana 22 - 25

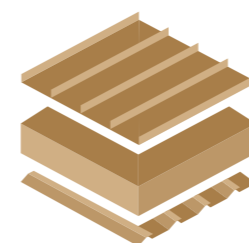

# JORISIDE

COMPONENTS

## O nama

Joris Ide je proizvođač građevinskog materijala specijalizovan za proizvodnju sendvič panela, profilisanih limova, imitacija crepa za krovove, zaptivača, zatvarača i galanterije.

Ponosimo se raznolikošću rešenja koja nudimo kako za industrijski tako i za stambeni sektor.

Naš cilj je da osiguramo da našim kupcima ponudimo proizvode i usluge koje su im potrebne u zavisnosti od projekta i da doprinesemo stvaranju dugoročnih partnerstava od koristi za obe strane.

2015. godine, grupa Kingspan u potpunosti preuzima Joris Ide grupu.

## Kontakt

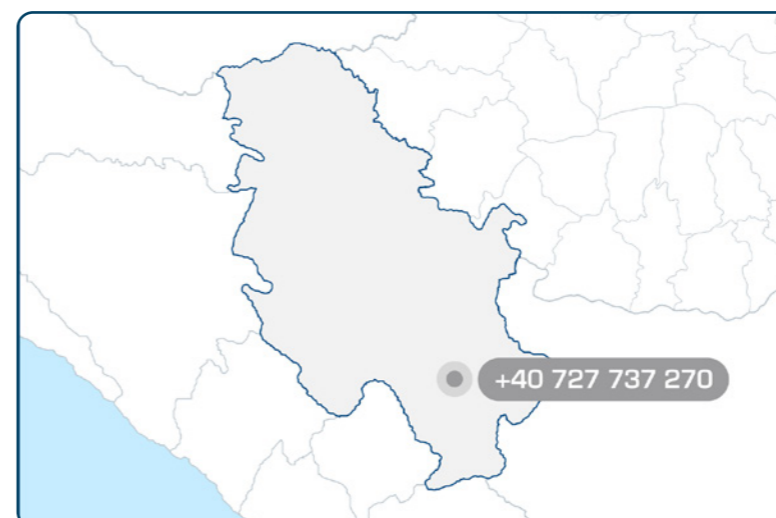

## Legenda

- \* - Ovi proizvodi se mogu izvoditi u galvanizovanoj varijanti
- A** - Spoljni deo
- B** - Unutrašnji deo
- PIR** - Polyisocyanurat
- VM** - Kamena vuna
- SF** - Skeiven spoj
- NF** - Vidljiv spoj

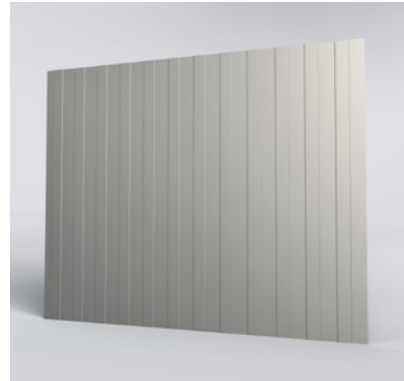

**Optic profil**

Debljina mm	Težina kg/m <sup>2</sup>
0,35	3,16
0,4	3,58
0,5	4,48
0,6	4,92
0,75	7,12

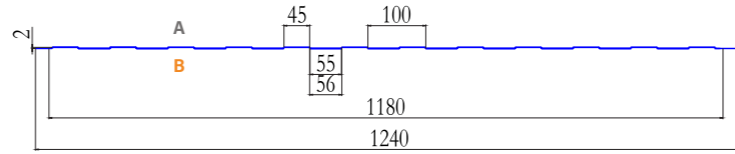

**8.116,5.1165\***

Debljina mm	Težina kg/m <sup>2</sup>
0,4	3,35
0,45	3,76
0,5	4,17
0,6	4,59
0,75	6,24

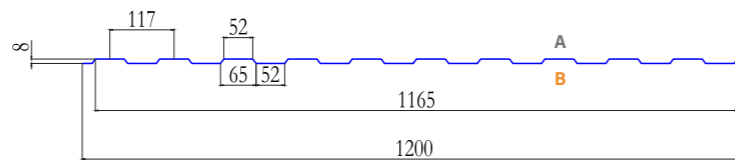

**16,5.137,5.1100\***

Debljina mm	Težina kg/m <sup>2</sup>
0,4	3,58
0,45	4,04
0,5	4,48
0,6	4,93

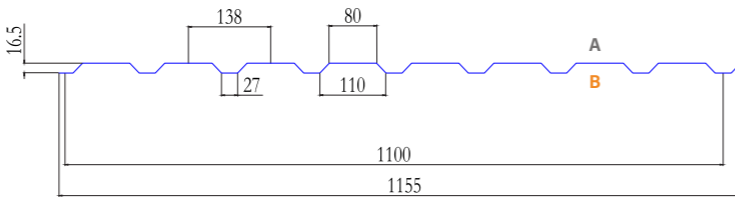

**18.135.1080\***

Debljina mm	Težina kg/m <sup>2</sup>
0,4	3,58
0,45	4,04
0,5	4,48
0,6	4,93

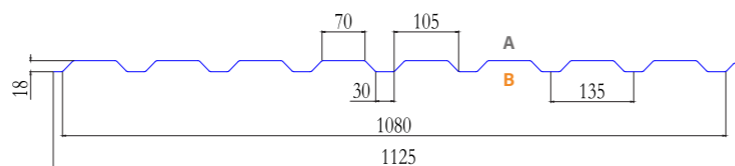

**35.207.1035\***

Debljina mm	Težina kg/m <sup>2</sup>
0,4	3,81
0,45	4,29
0,5	4,76
0,6	5,24
0,75	7,12

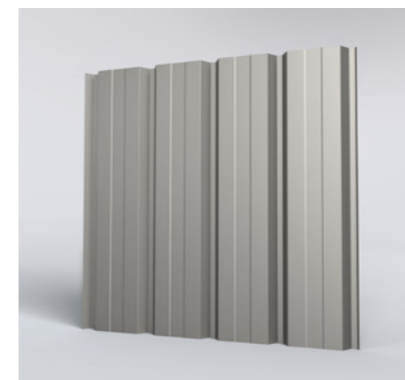
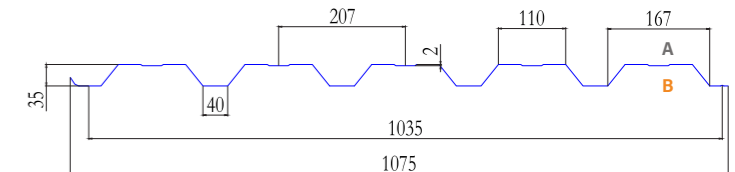

**38.250.1000\***

Debljina mm	Težina kg/m <sup>2</sup>
0,4	3,94
0,45	4,44
0,5	4,92
0,6	5,42
0,75	7,34

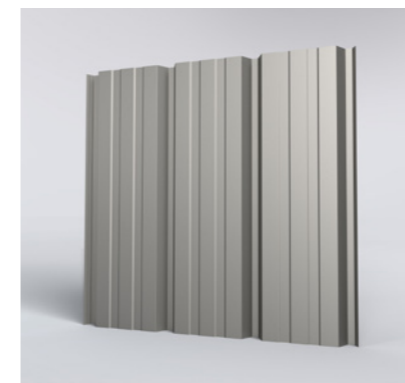
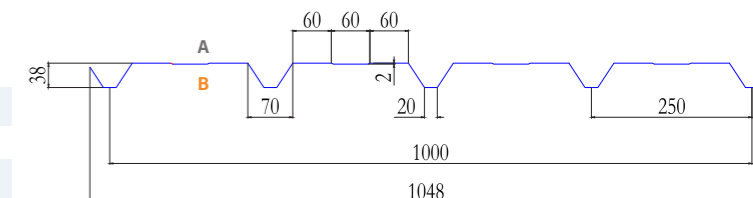

**45.333.1000\***

Debljina mm	Težina kg/m <sup>2</sup>
0,4	3,94
0,45	4,44
0,5	4,92
0,6	5,42
0,75	7,37

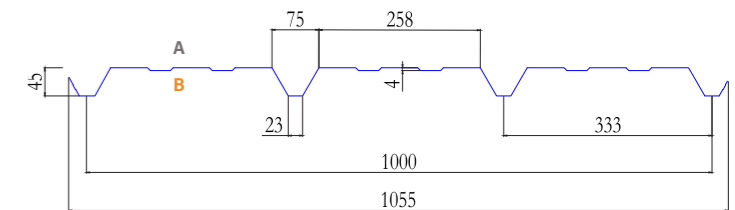

**76.18.988 Sinusoidal\***

Debljina mm	Težina kg/m <sup>2</sup>
0,4	3,97
0,45	4,46
0,5	4,96
0,6	5,46
0,75	7,14

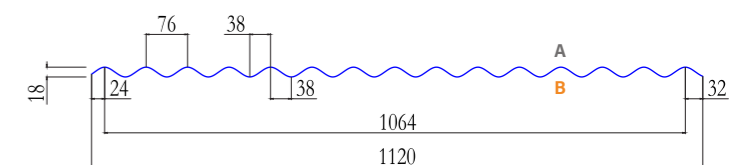



**16.5.137,5.1100\***

Debljina mm	Težina kg/m <sup>2</sup>
0,35	3,16
0,4	3,58
0,5	4,48
0,6	4,92

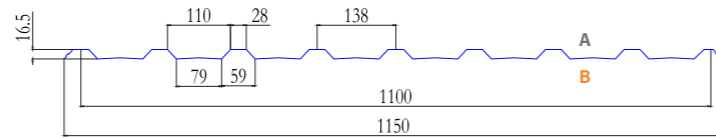

**18.135.1080\***

Debljina mm	Težina kg/m <sup>2</sup>
0,35	3,16
0,4	3,58
0,5	4,48
0,6	4,92
0,75	7,12

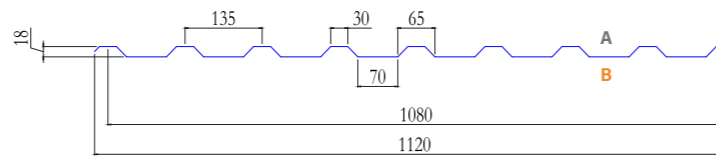

**35.207.1035\***

Debljina mm	Težina kg/m <sup>2</sup>
0,35	3,44
0,4	3,81
0,45	4,29
0,5	4,76
0,6	4,92
0,75	7,12

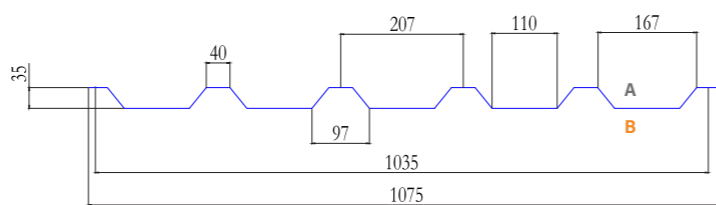

**35.500.1000\***

Debljina mm	Težina kg/m <sup>2</sup>
0,35	2,82
0,4	3,2
0,45	3,6
0,5	4

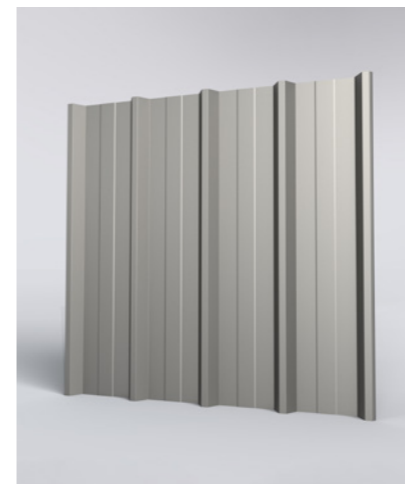
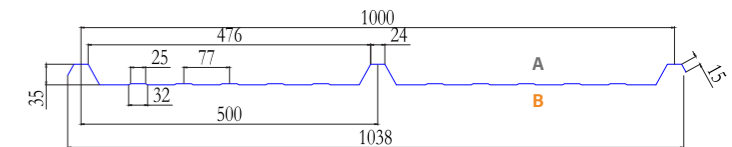

**38.250.1000\***

Debljina mm	Težina kg/m <sup>2</sup>
0,35	3,44
0,4	3,94
0,45	4,44
0,5	4,92
0,6	4,92
0,75	7,34

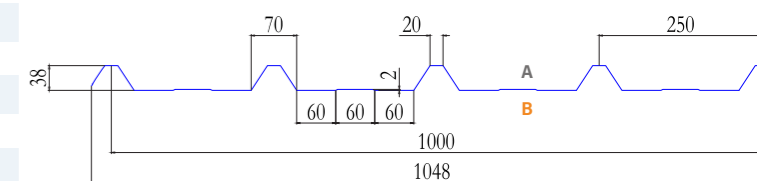

**45.333.1000\***

Debljina mm	Težina kg/m <sup>2</sup>
0,35	3,44
0,4	3,94
0,45	4,44
0,5	4,92
0,6	4,92
0,75	7,37

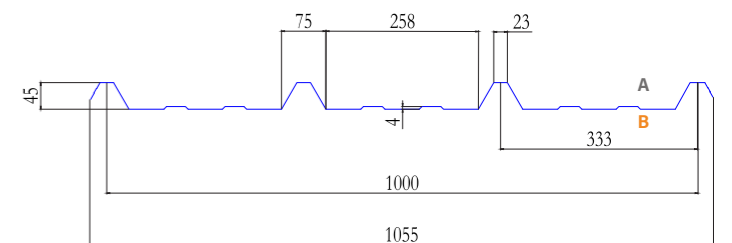



**58.210.820\***

Debljina mm	Težina kg/m <sup>2</sup>
0,75	8,77
1,00	11,28

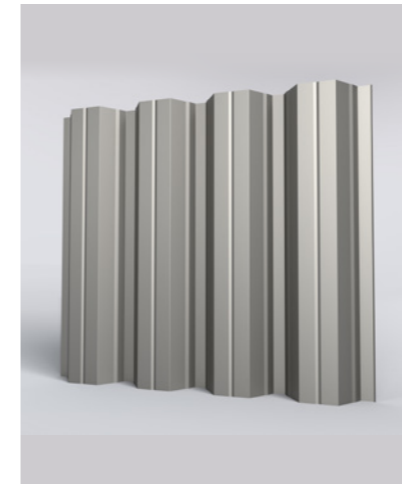
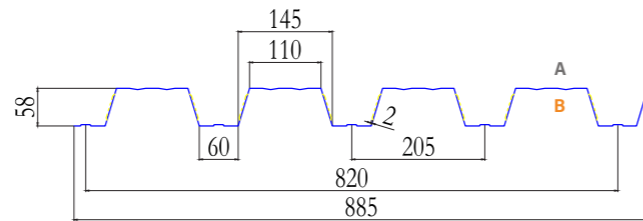

**85.280.1120**

Debljina mm	Težina kg/m <sup>2</sup>
0,75	10,10
0,88	11,83
1	13,43
1,25	15,16

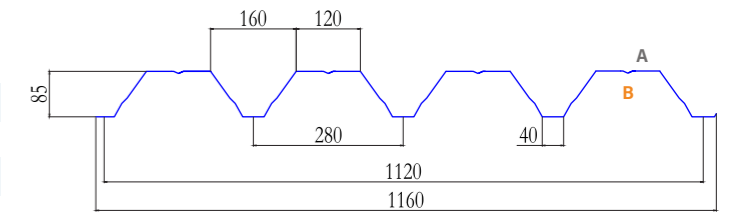

**153.280.840**

Debljina mm	Težina kg/m <sup>2</sup>
0,75	10,61
0,88	12,43
1	14,11
1,25	17,61

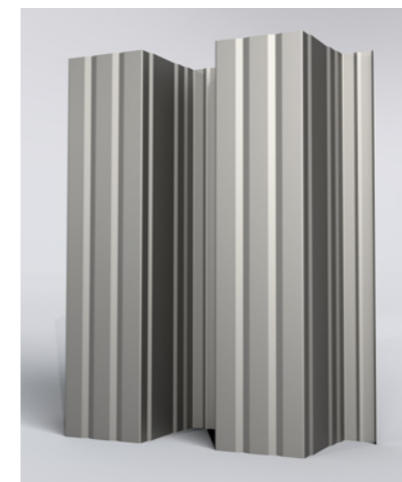
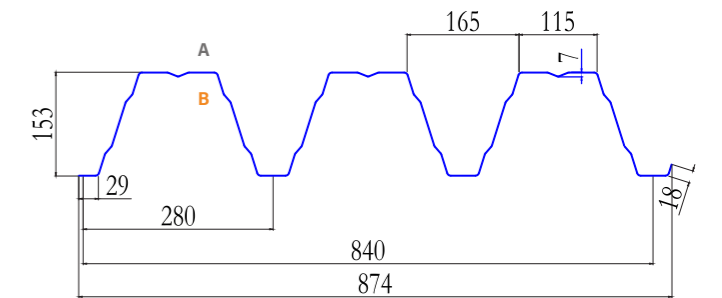

**200.420.840**

Debljina mm	Težina kg/m <sup>2</sup>
0,75	10,61
0,88	12,43
1	14,11
1,25	17,61

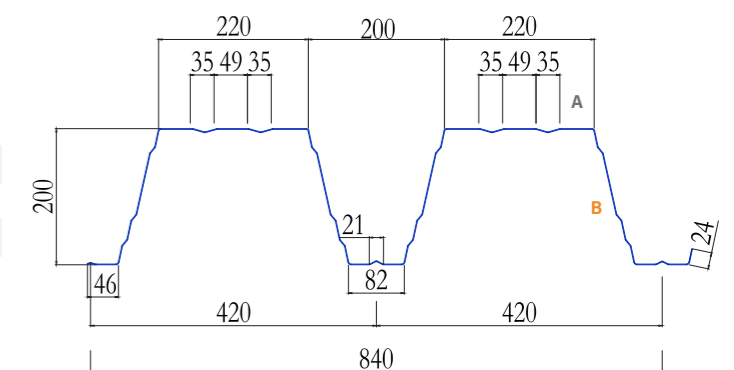

! Profil 58 sadrži utiskivanje na pregibima.

! Dužina profila koji se proizvodi je između 1,5 m i 13,5 m.

**Profil Z**

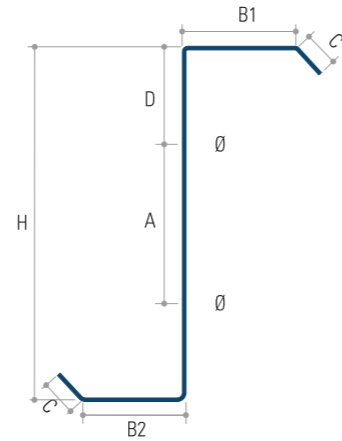
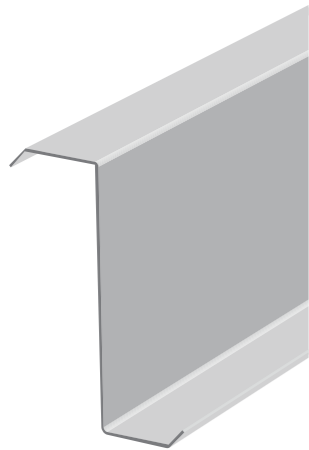

**Profil C**

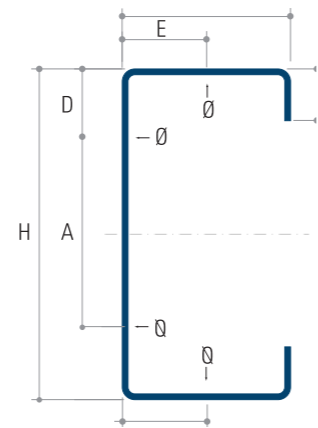
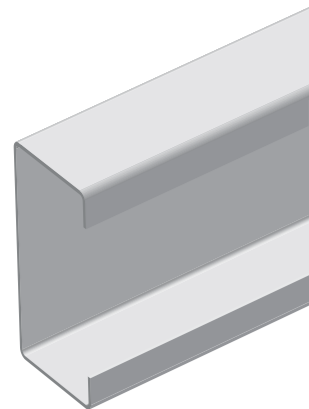

**Profil Sigma**

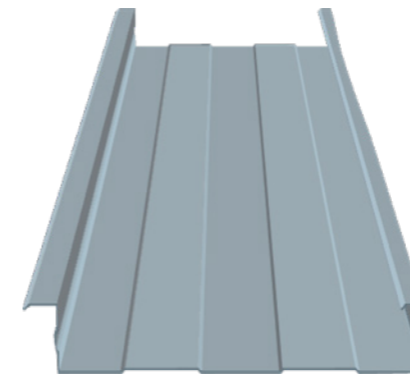
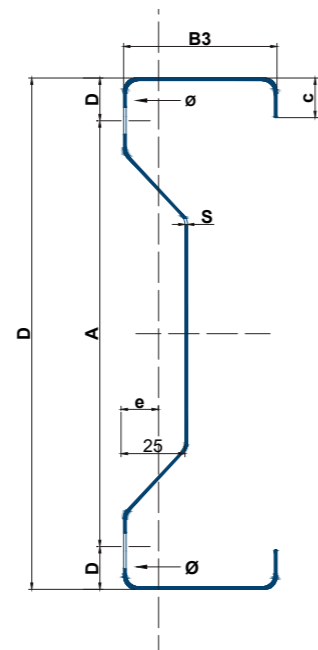
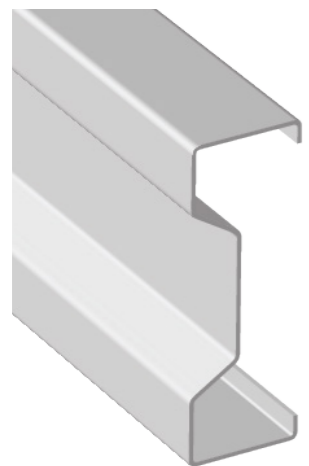

**Kaseta 115.600**

**Debljina**  
mm  
0,75  
0,88  
1

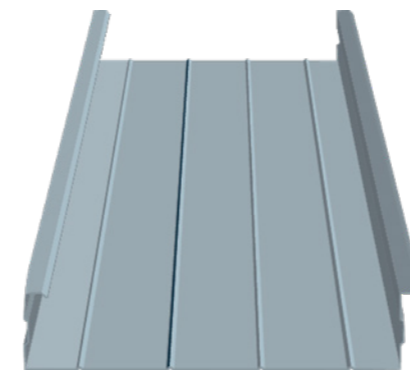
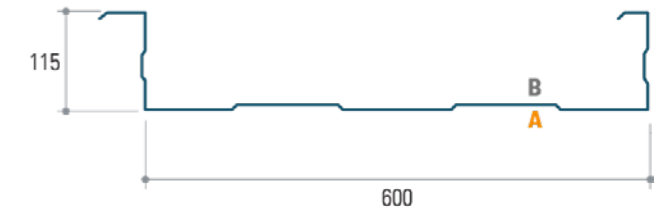

**Kaseta 125.600**

**Debljina**  
mm  
0,75  
0,88  
1

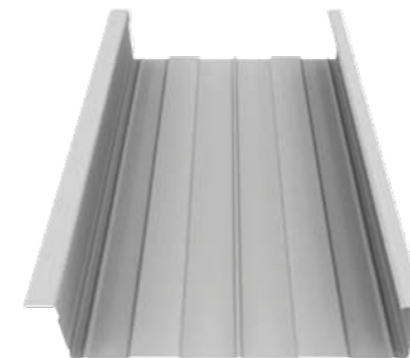
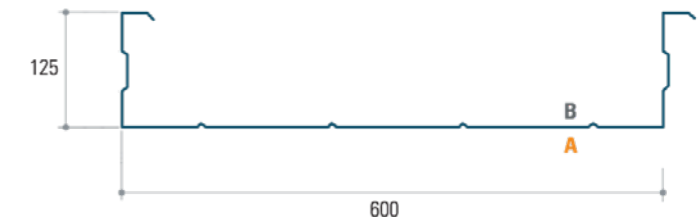

**Kaseta 160.600**

**Debljina**  
mm  
0,75  
0,88  
1

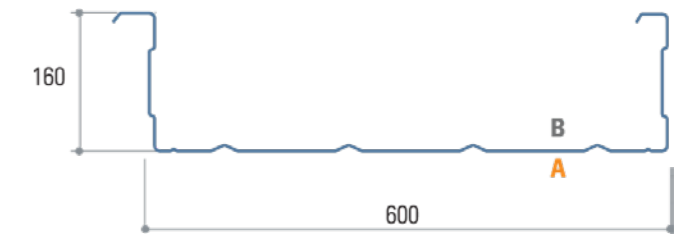



**Plank profil**

Minimalne dimenzije  
8 m - dužina  
0,75 - debljina

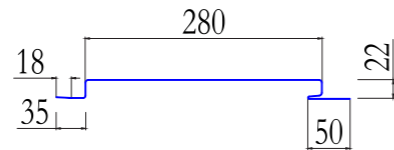

**Diagram montiranja plank tipa profila**

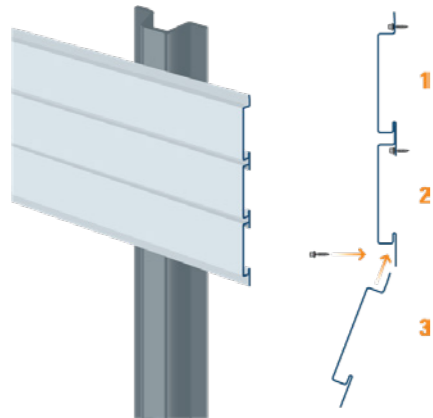

**Diagram završnih profila, mogućnosti spajanja**

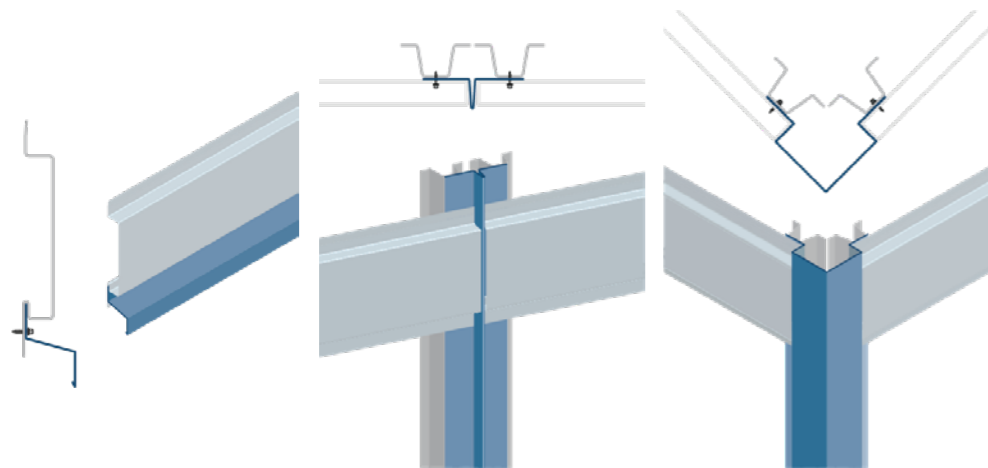

Slaganje

Vertikalni spoj

Ugao



**Krovni panel PIR 3 rebra**

Debljina mm	Težina kg/m <sup>2</sup>
40	8,60
50	8,97
60	9,34
80	10,10
100	10,80
125	11,70

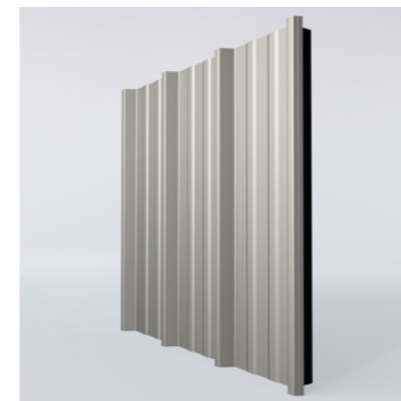
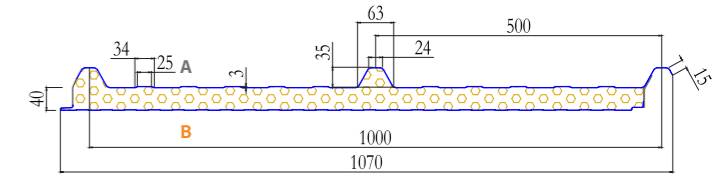

**Krovni panel PIR 4 rebra**

Debljina mm	Težina kg/m <sup>2</sup>
40	9,93
50	10,44
60	10,72
80	11,48
100	12,30
125	13,33

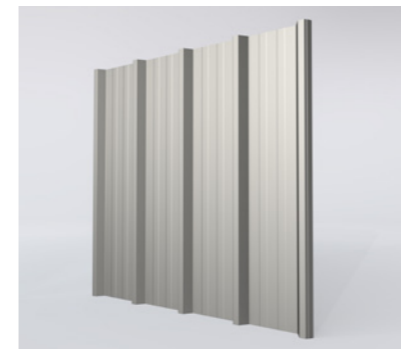
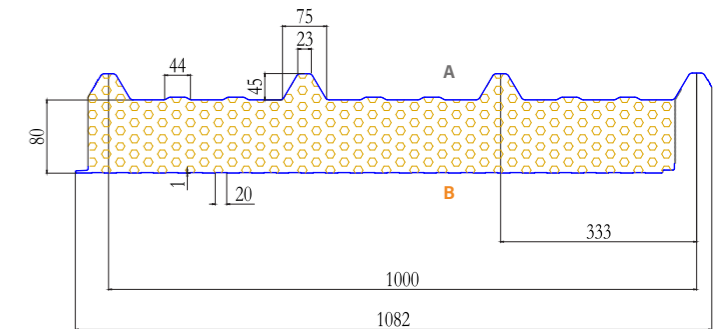

**Krovni panel VM**

Debljina mm	Težina kg/m <sup>2</sup>
60	16,18
80	18,18
100	20,18
120	22,18
150	25,18
180	28,18
200	30,18

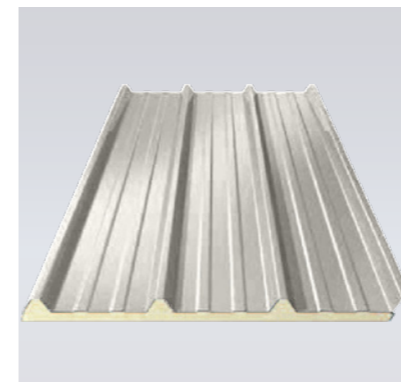
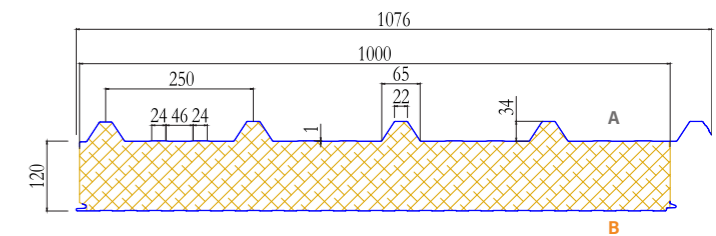

**PIR Agropanel**

Debljina mm	Težina kg/m <sup>2</sup>
30	7,15
40	7,55
50	7,95
60	8,34
80	9,53
100	10,72
125	12,2
150	13,5

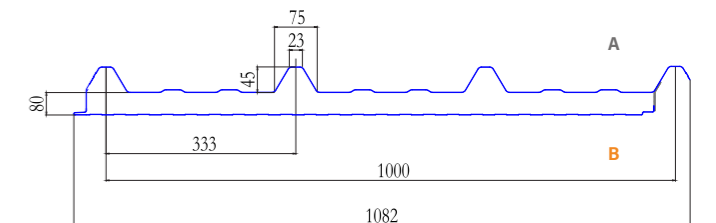

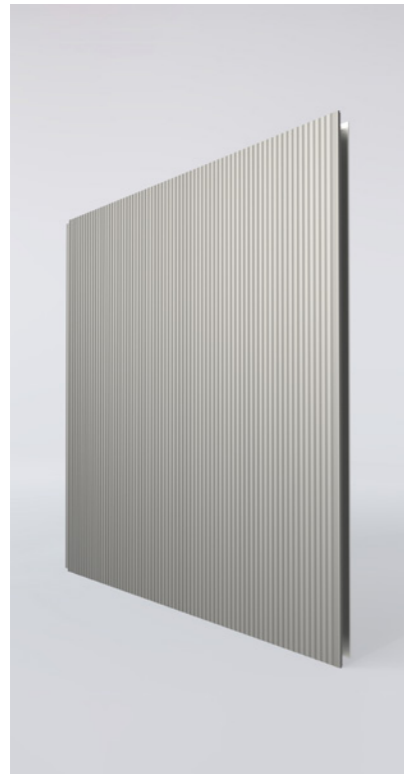

**Zidni panel PIR SF**

Debljina mm	Težina kg/m <sup>2</sup>
40	9,93
50	10,44
60	10,72
80	11,43
100	12,30
120	13,74

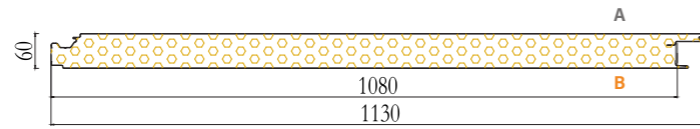

**Zidni panel VM SF**

Debljina mm	Težina kg/m <sup>2</sup>
60	17,44
80	19,80
100	22,16
120	24,52
150	28,06
180	31,67
200	33,96

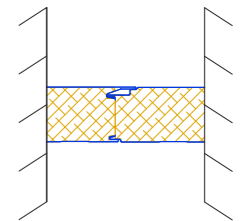
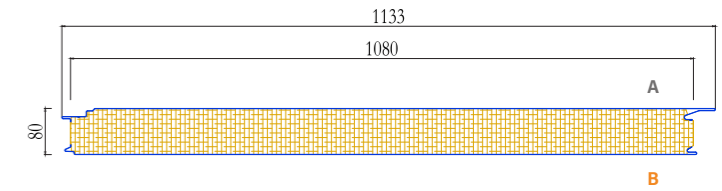

**Zidni panel PIR NF**

Debljina mm	Težina kg/m <sup>2</sup>
30	9,34
40	9,93
50	10,44
60	10,72
80	11,43
100	12,30
120	13,74
150	14,94
165	15,51

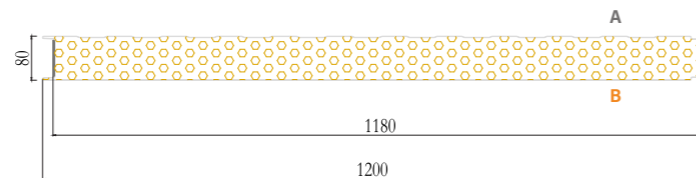

Mogući načini spajanja:

≥100mm

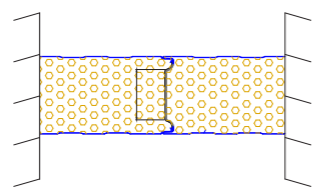

<100mm

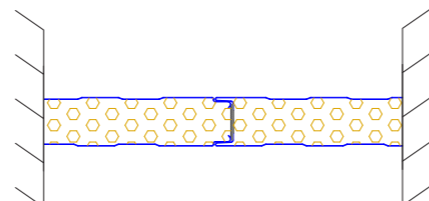

**Zidni panel VM NF**

Debljina mm	Težina kg/m <sup>2</sup>
60	17,44
80	19,80
100	22,16
120	24,52
150	28,06
180	31,67
200	33,96

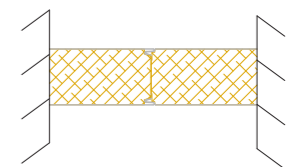
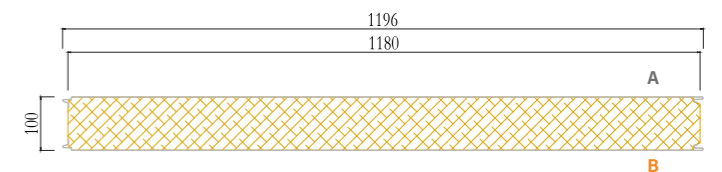



**Zidni paneli VM SF**  
Raspoloživa profilacija:



**M-O (micro-optic)**

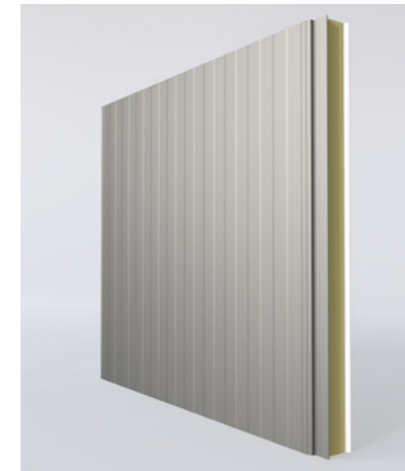
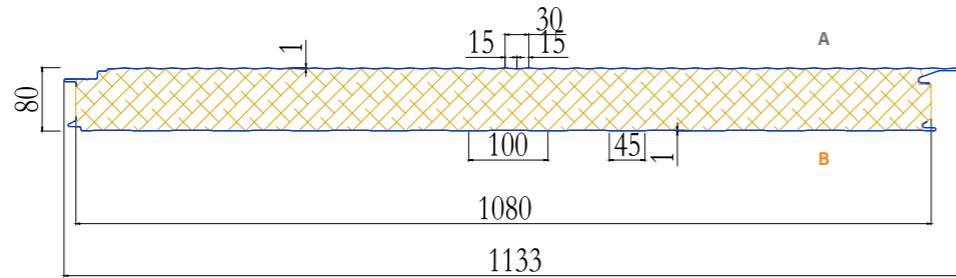

**O-L (optic-flat)**

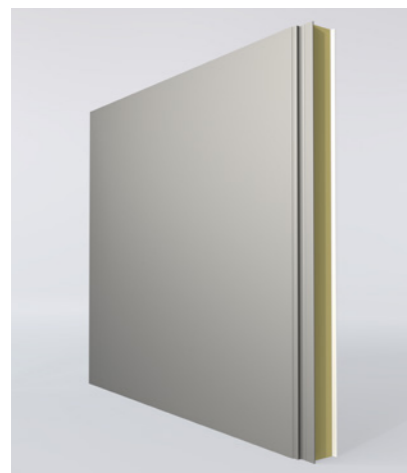
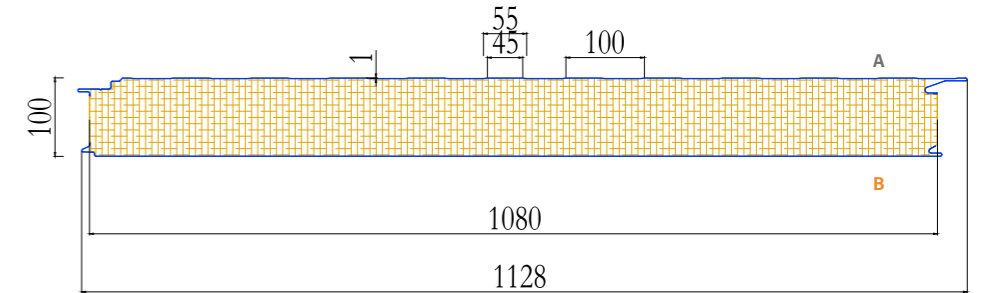

**L-O (flat-optic)**

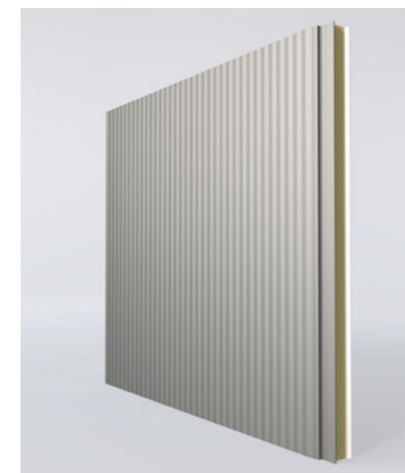
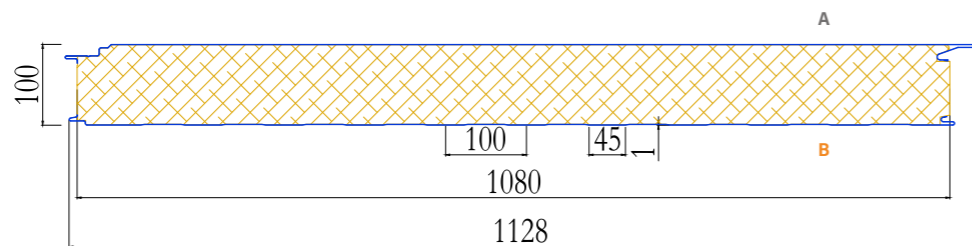

**M-L (micro-flat)**

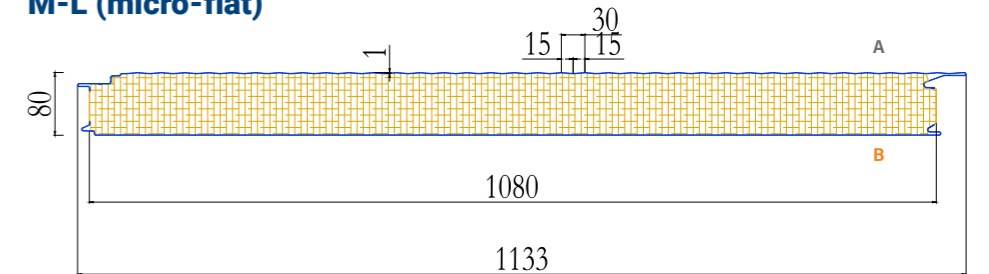

**O-O (optic-optic)**

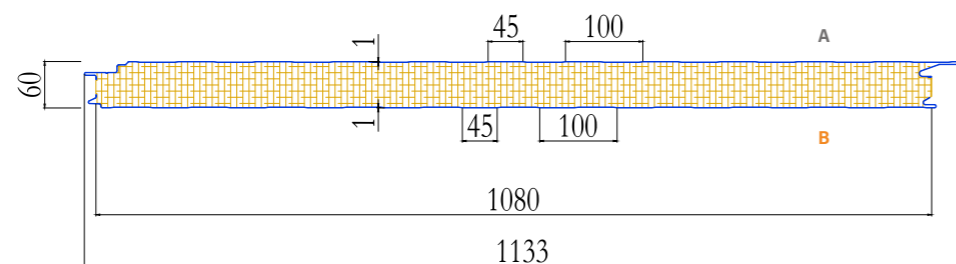

**L-L (flat-flat)**

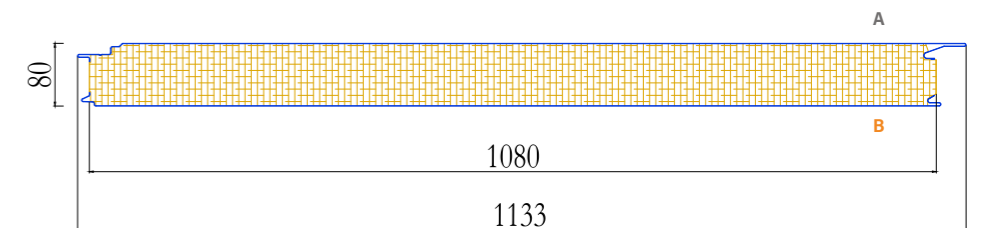

**Zidni paneli VM NF**  
Raspoloživa profilacija:



**M-O (micro-optic)**

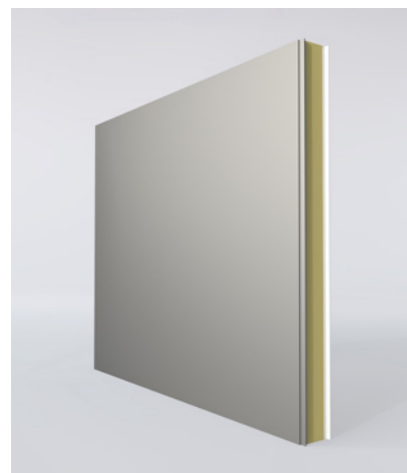
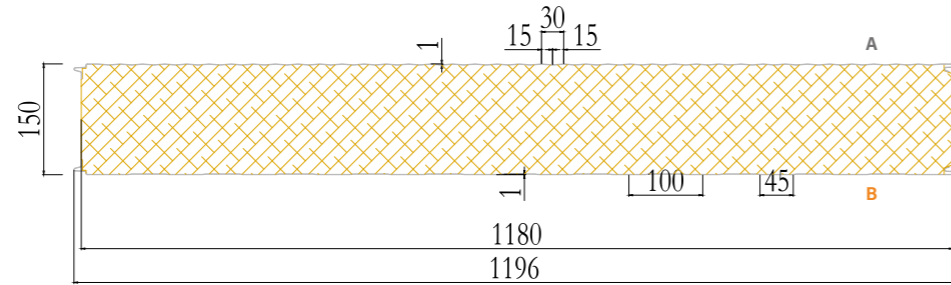

**L-O (flat-optic)**

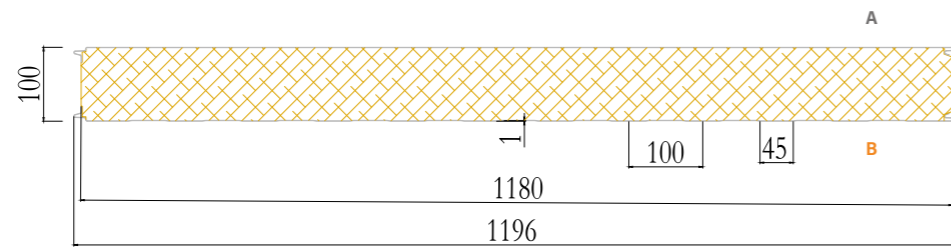

**O-O (optic-optic)**

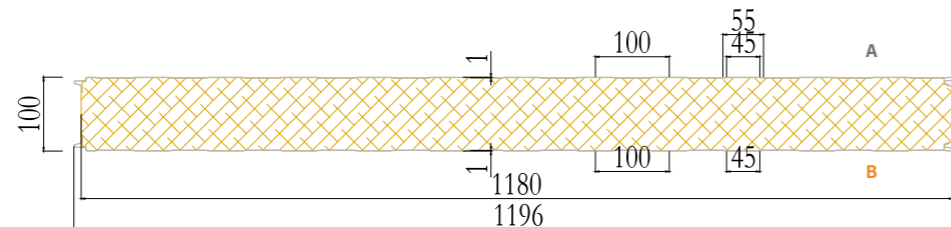

**O-L (optic-flat)**

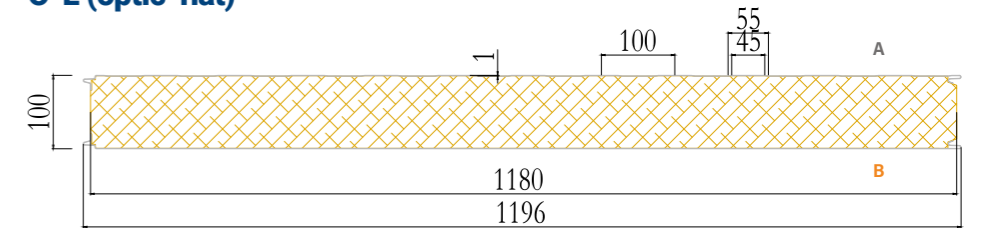

**M-L (micro-flat)**

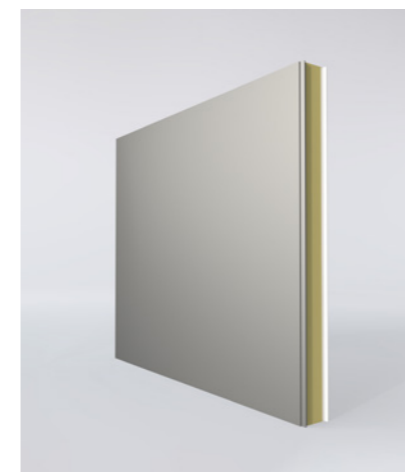
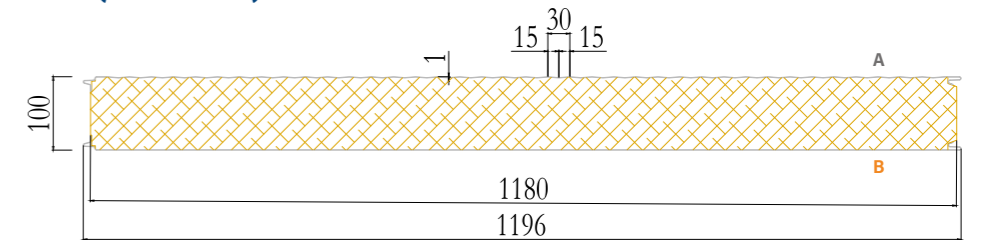

**L-L (flat-flat)**

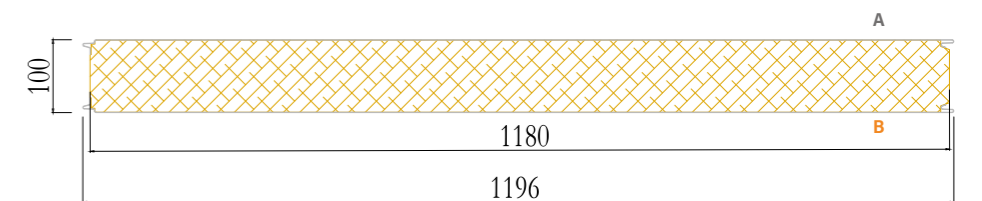

**Zidni paneli PIR SF**  
Raspoloživa profilacija:

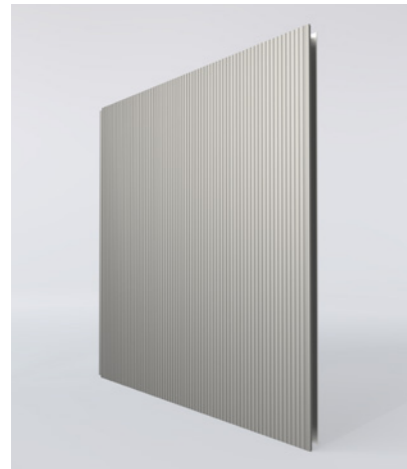

**M-O (micro-optic)**

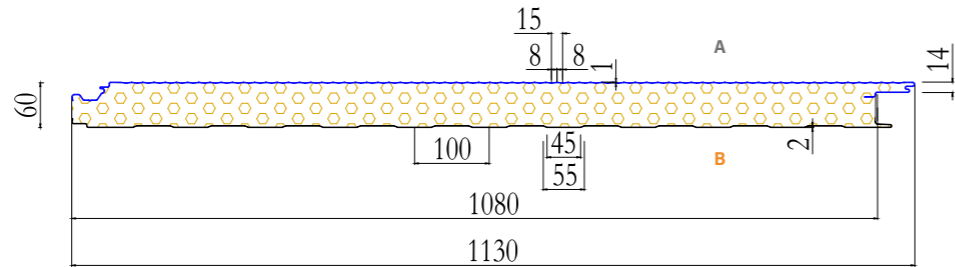

**O-L (optic-flat)**

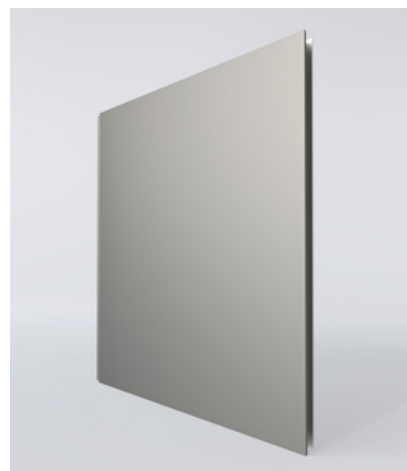
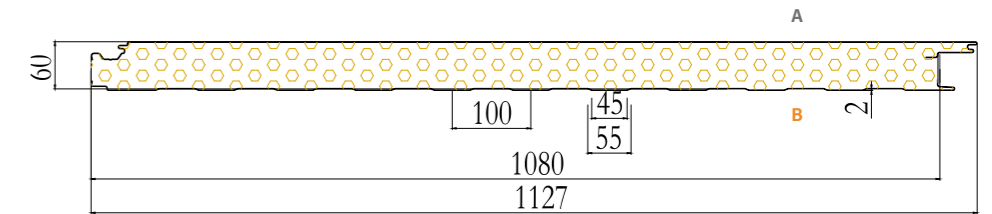

**L-O (flat-optic)**

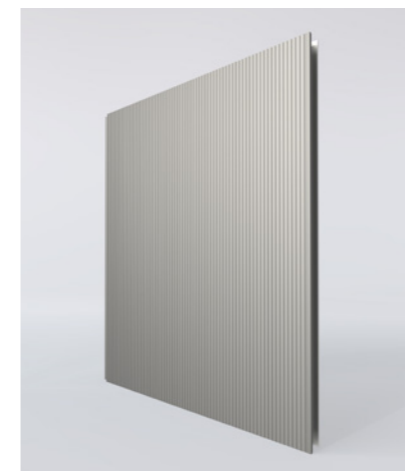
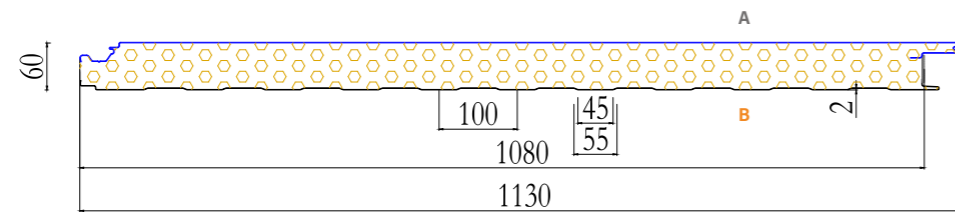

**M-L (micro-flat)**

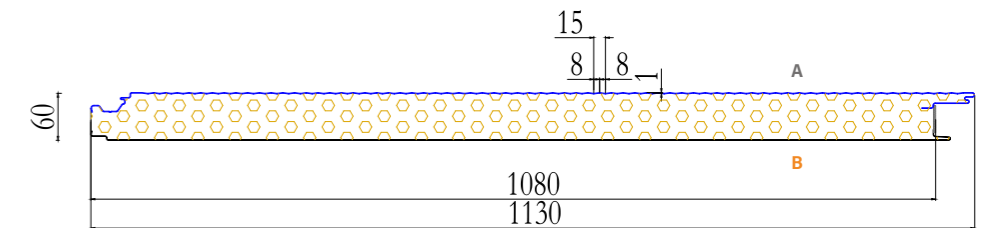

**O-O (optic-optic)**

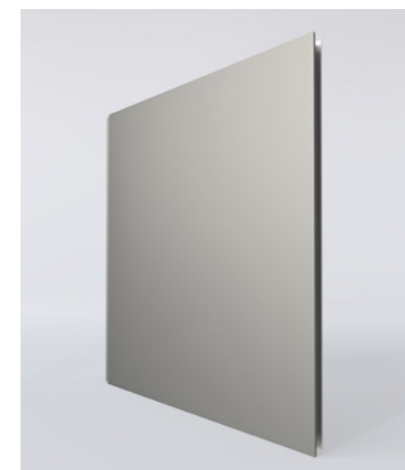
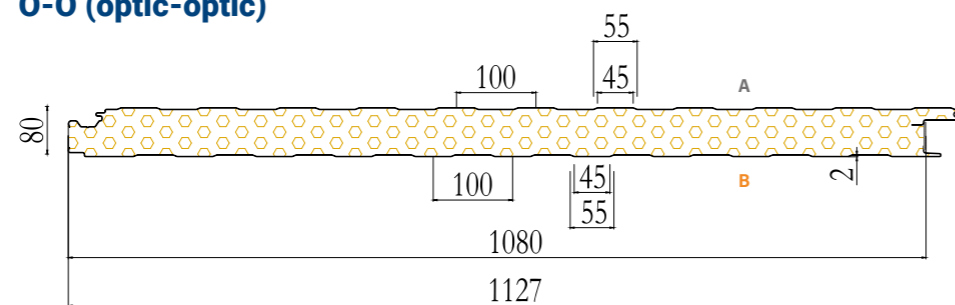

**L-L (flat-flat)**

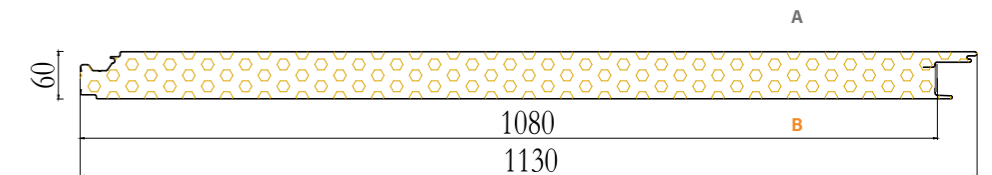

**Zidni paneli PIR NF**  
Raspoloživa profilacija:



**M-O (micro-optic)**

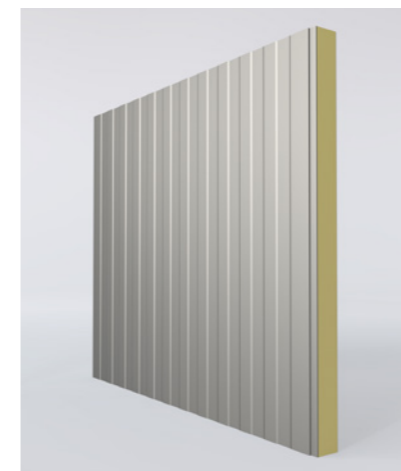
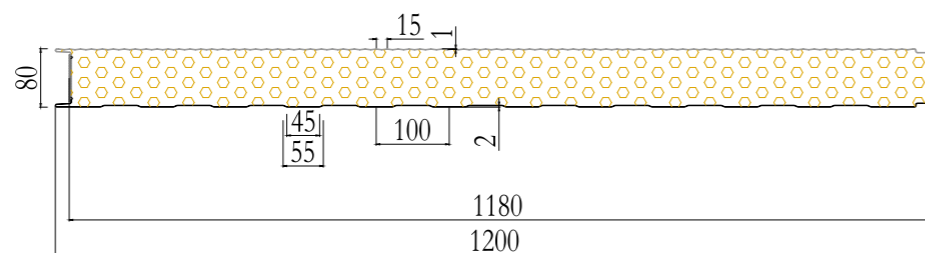

**O-L (optic-flat)**

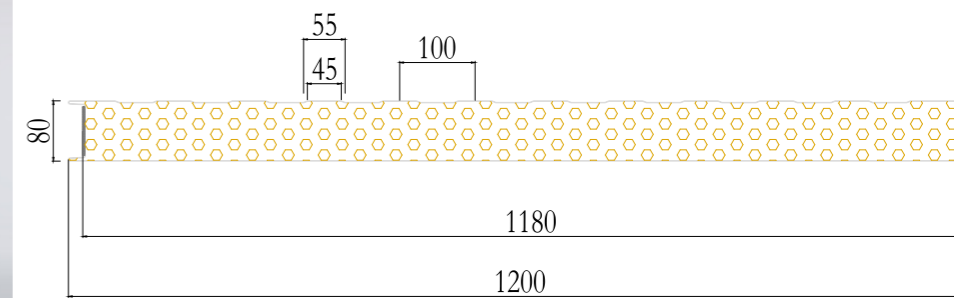

**L-O (flat-optic)**

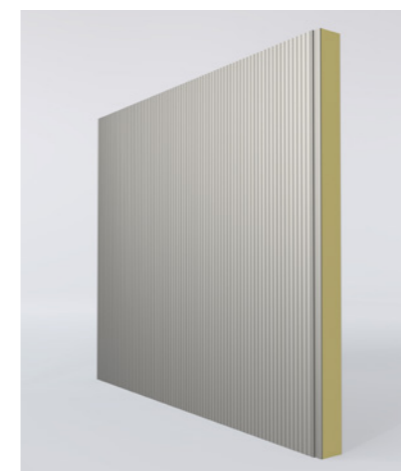
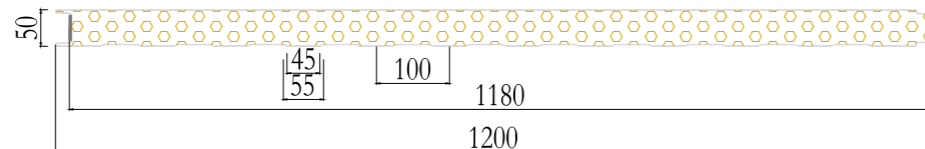

**M-L (micro-flat)**

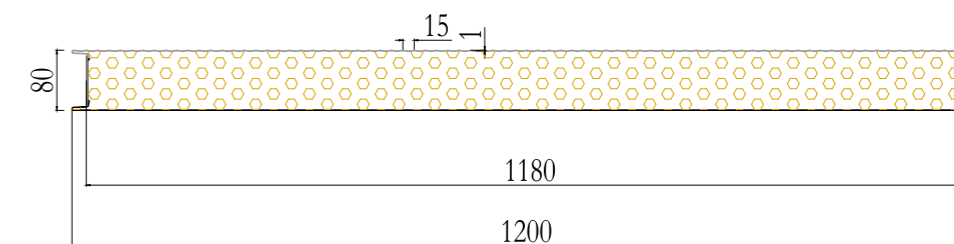

**O-O (optic-optic)**

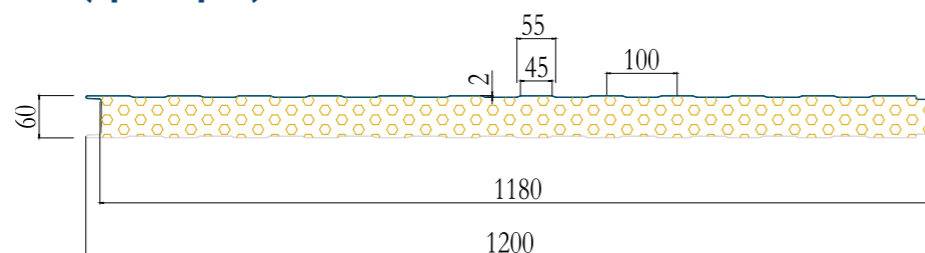

**L-L (flat-flat)**

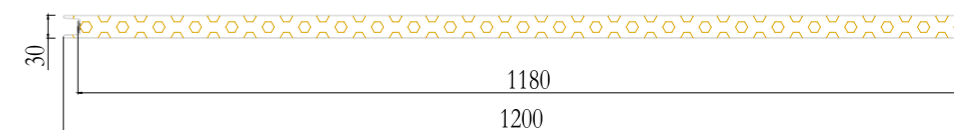

**Dodaci**

Dodaci za zaptivanje i izolaciju

**Dodaci**

Svetlarnici



**Adhezivna traka IZOBUTYL**  
(15 mm x 60 ml)



**Zaptivna guma**  
D60 mm – D475 mm



**Silikon Aquafix**

16,5.137,5.1100

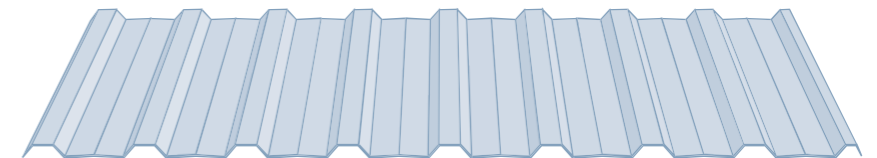

**Univerzalna samolepljiva traka (dolie)** (dužina 1000 mm)



**Plastična zaštita od ptica**  
(dužina 1000 mm)

34.207.1035

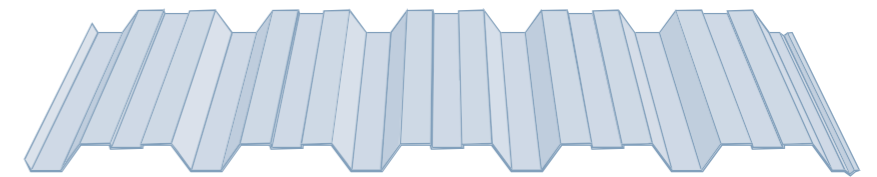

**Boja za retuširanje**

38.250.1000

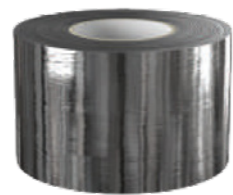
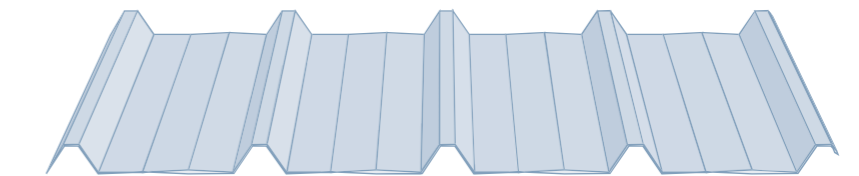

**Alu traka**  
(100 mm / 150 mm / 300 mm x 10 ml)



**IZOLEN traka za zaptivanje**  
(0,31 x 5 m)

45.333.1000

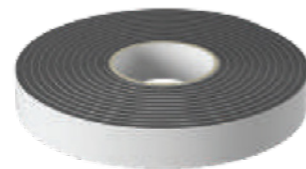
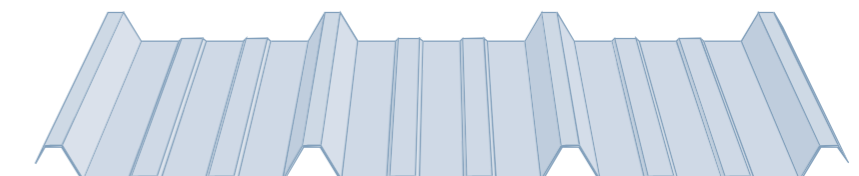

**IZOLANT ekspanzibilna traka**  
(30 X 8/4 mm)

35.500.1000

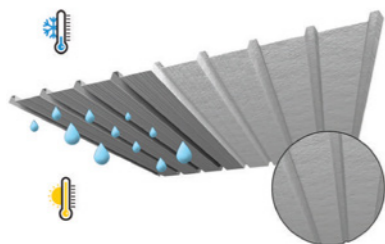
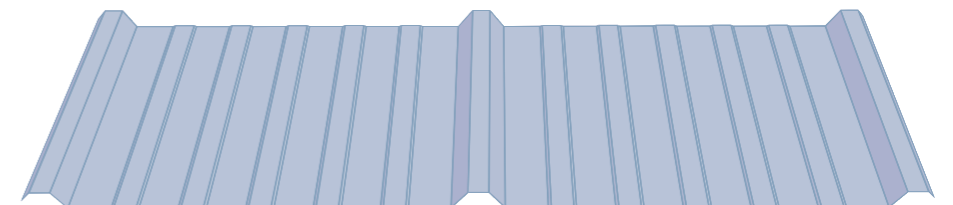

**Membrana DRIPSTOP**

GRECA

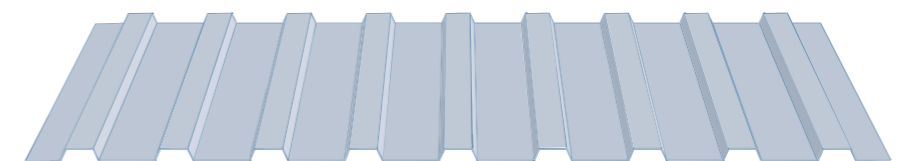

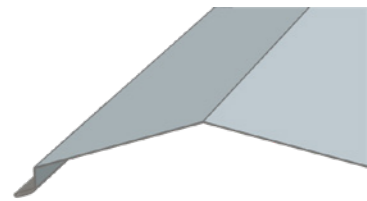

**Nadstrešnica sa padom**

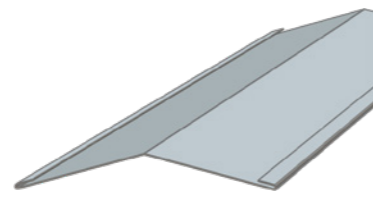

**Podnastrešnica**

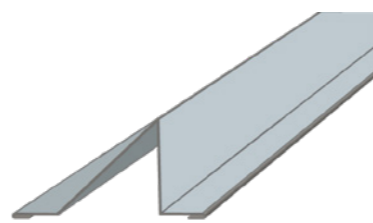

**Zaustavljač snega**

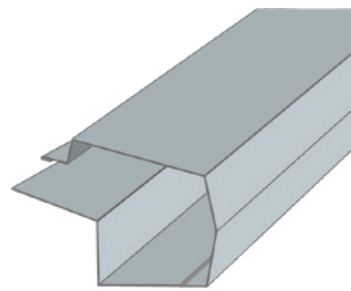

**Metalni oluk**

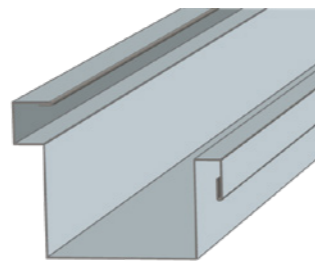

**Metalni oluk**

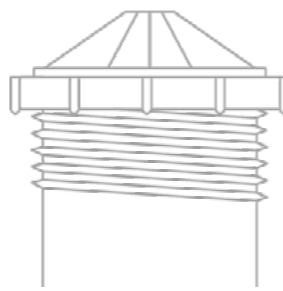

**Učvršćivač**

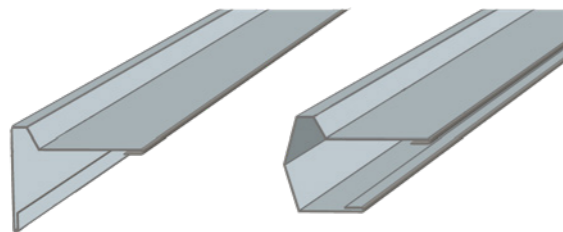

**Vetar lajsna**

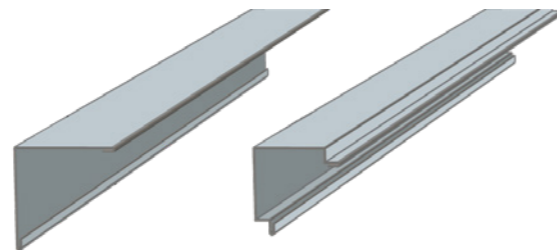

**Ivičnjak**

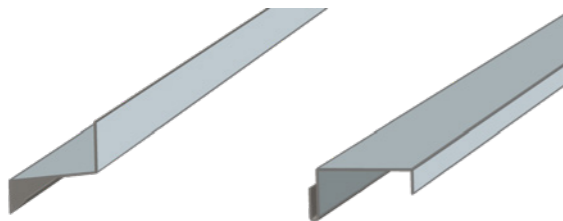

**Okapnice**

**ZAVRŠNI PROFILI**

Uz konsultaciju sa našim odeljenjem prodaje, svi profili se mogu sklopiti prema zahtevima kupaca (maksimalna dužina 6m)

**MONTAŽA ZAVRŠNIH PROFILA**

Za nesmetanu montažu završnih profila, oni moraju biti zaptiveni i montirani jedan na drugi. Za zaptivanje profila koristi se sredstvo za zaptivanje (butil traka).

Svi postupci sečenja moraju se obaviti na gradilištu. Uobičajena preklapanja dostižu do 10cm. Pravac poprečnih preklapanja određen je prevladajućim smerom vetrova i kiše. Pričvršćivanje se vrši pomoću samoreznih ili samoperforirajućih vijaka sa zaptivnom smešom.



**Cev / produžna cev**



**Prsten za cev**



**Ugaonik za oluk**



**Y spojka za cev**



**Olučenje za odvod 60**



**Deo za spajanje oluka**

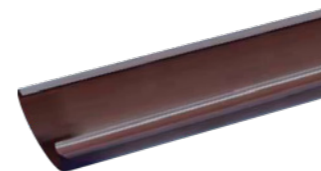

**Oluk**



**Završn deo vrha**



**Završni deo oluka**



**Kuka za oluk**



**Levak**



**Olučenja - spoj 60**



**JORISIDE**  
COMPONENTS

 +40 727 737 270

 **Joris Ide Romania**

Sve tehničke informacije koje je Prodavac dao pre i/ili tokom upotrebe proizvoda, usmeno i pismeno, date su u dobroj veri i u skladu sa znanjem koje on u tom trenutku poseduje. Međutim, ove informacije ne utiču na obavezu kupca da proceni proizvode koje mu isporučuje prodavac sa stanovišta podobnosti i kompatibilnosti sa sredstvima obrade i/ili aplikacijama za koje kupac želi da koristi proizvode i naknadno da se oslanja isključivo na ove procene. Odgovornost u pogledu upotrebe i obrade proizvoda za određenu primenu snosi isključivo kupac.

Kako slike, tako i tehnički podaci predstavljeni u brošuri su striktno orijentativnog karaktera.

Avgust 2023.