



PORTOFOLIO PROIZVODA

JORISIDE
THE STEEL FUTURE

JORISIDE

THE STEEL FUTURE

Joris Ide je strateški proizvođač čeličnih panela za zidove i krovove, prisutan preko 30 godina na međunarodnim tržištima. Naša rešenja se prilagođavaju svakoj vrsti projekta, bilo da govorimo o industrijskom, poljoprivrednom, komercijalnom ili stambenom sektoru, bilo da govorimo o novogradnji ili renoviranju. Razvijena su, projektovana i proizvedena na takav način da obezbede bezbednost, izdržljivost, efikasnost i tehničke performanse po najvišim standardima.

Naš portfolio proizvoda obuhvata širok asortiman profila za zidove i krovove, sendvič panele, panele imitacije crepova, perma pločice, pocinkovane profile, kao i razne vrste prateće dodatne opreme i za klizne kapije.

Godine 2015, **Kingspan** grupa je u potpunosti preuzela Joris Ide grupu, čiji je deo i **Joris Ide Rumunija**.

KONTAKT

MUNTENIA	Ciprian Holban	+40 726 204 161
	Claudiu Sprinceana	+40 752 164 891
	Sebastian Dragomir	+40 756 077 419
BANAT	Adina Cosovan	+40 722 403 168
	Ovidiu Unchesu	+40 756 076 512
	Marcela Holodinschi	+40 752 142 682
OLTENIA	Iulian Zamfir	+40 752 102 284
	Bogdan Guna	+40 758 066 885
MOLDOVA	Cosmin Archip	+40 744 334 847
	Ionut Savin	+40 724 323 996
	Roxana Oneagă	+40 756 076 518
	Ovidiu Dragomir	+40 726 333 929
R.MOLDOVA	Victor Popa	+37 36 822 3220
TRASILVANIA	Bogdan Puîu	+40 751 070 386
	Gabriel Naznean	+40 751 085 406
	Octavian Marele	+40 724 298 246
UNGARIA	Gabor Galambos	+36 303 269 151
SERBIA	Iota Buzarski	+40 727 737 270

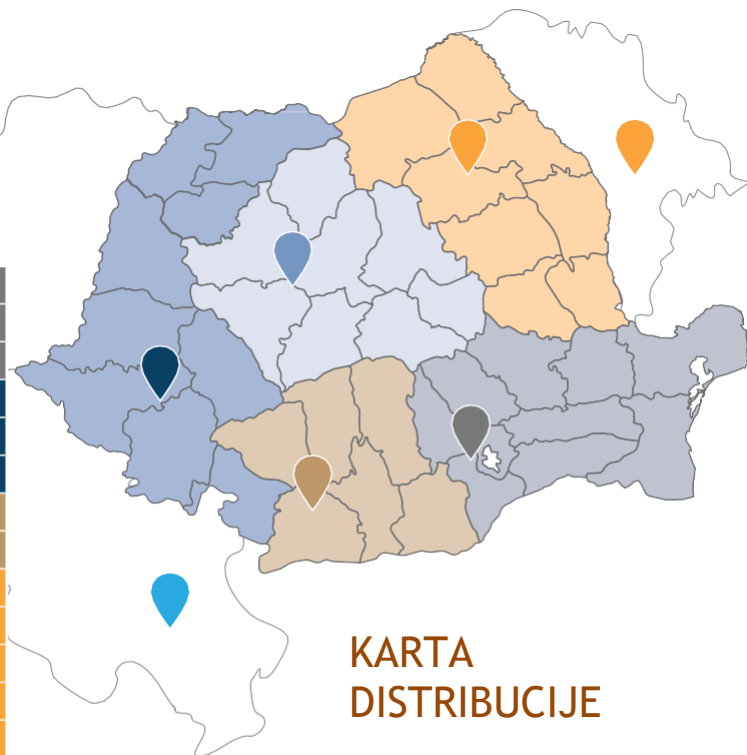

JORISIDE

SADRŽAJ

ZAKRIVLJENI LIM	03
Zakrivljeni lim za zidove.....	03
Zakrivljeni lim za krovove.....	05
Zakrivljeni lim za podove i unutrašnje zidne obloge.....	07
OPTIQUE valoviti lim.....	07
Visoki zakrivljeni lim - ravni krovovi.....	07
PLANCHE zakrivljeni lim.....	09
SENDVIČ PANELI	10
Krovni paneli.....	10
Zidni paneli.....	11
Dostupni profili za zidne panele VM - SF.....	13
Dostupni profili za zidne panele VM - NF.....	15
Dostupni profili za zidne panele PIR - SF.....	17
Dostupni profili za zidne panele PIR - NF.....	19
DODATNA OPREMA	21
Pribor za zaptivanje i izolaciju.....	21
Transparentne ploče.....	22
Pribor za završnu obradu metala.....	23
Sistem oluka.....	25

ZAKRIVLJENI LIM ZID



JIS 8-116,5-1165*

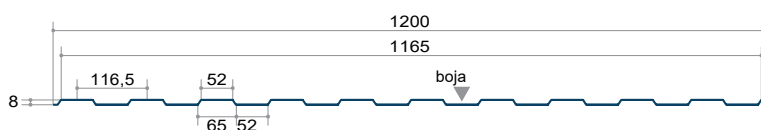

DEBLJINA (mm)	TEŽINA (kg/m ²)
0,40	3,92
0,45	3,76
0,50	4,7
0,60	4,59



JIS 10-138-1100**

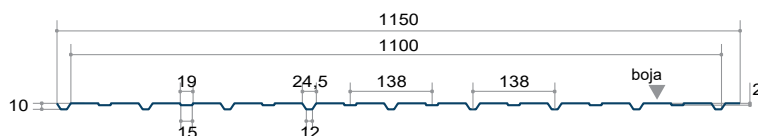

DEBLJINA (mm)	TEŽINA (kg/m ²)
0,40	3,92
0,45	3,76
0,50	4,17
0,60	4,59
0,75	6,24



JIS 16,5-137,5-1100

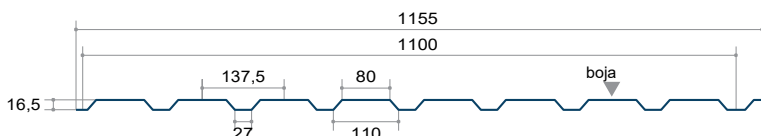

DEBLJINA (mm)	TEŽINA (kg/m ²)
0,40	3,58
0,45	4,04
0,50	4,48
0,60	4,93



JIS 18-135-1080

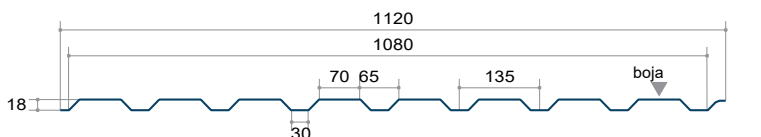

DEBLJINA (mm)	TEŽINA (kg/m ²)
0,40	3,58
0,45	4,04
0,50	4,48
0,60	4,93

*Ovaj profil je dostupan i u kratkoj varijanti od 930 mm.
**Ovaj profil se nalazi i na kratkoj verziji od 828 mm.

ZAKRIVLJENI LIM ZID



Jl 18-076-988 (sinus)

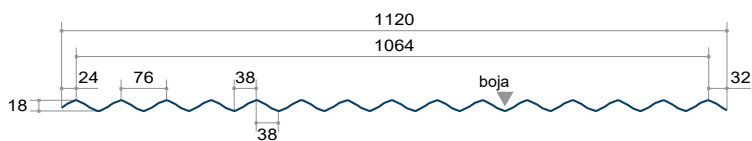

DEBLJINA (mm)	TEŽINA (kg/m ²)
0,40	3,97
0,45	4,46
0,50	4,96
0,60	5,45
0,75	7,14



JIS 35-207-1035

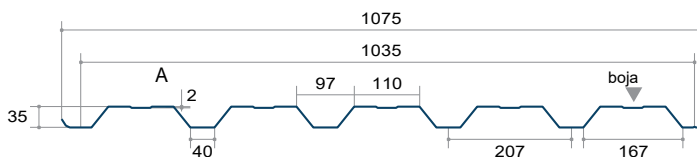

DEBLJINA (mm)	TEŽINA (kg/m ²)
0,40	3,81
0,45	4,29
0,50	4,76
0,60	5,24
0,75	7,12



JIS 38-250-1000

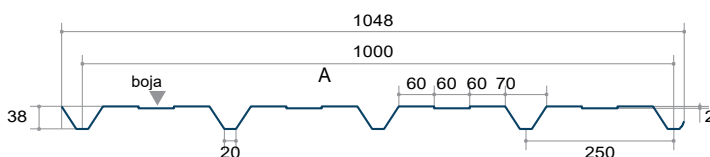

DEBLJINA (mm)	TEŽINA (kg/m ²)
0,40	3,94
0,45	4,44
0,50	4,92
0,60	5,42
0,75	7,34



Jl 45-333-1000

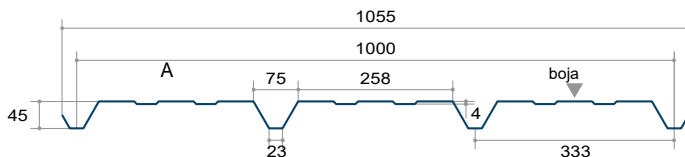

DEBLJINA (mm)	TEŽINA (kg/m ²)
0,40	3,94
0,45	4,44
0,50	4,92
0,60	5,42
0,75	7,37

ZAKRIVLJENI LIM ZID



JIS 16,5-137,5-1100

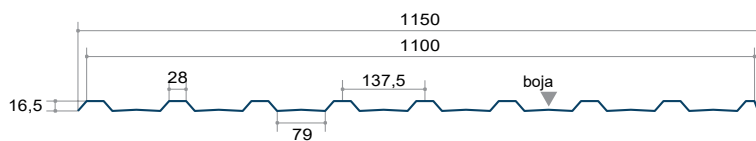

DEBLJINA (mm)	TEŽINA (kg/m ²)
0,35	3,16
0,40	3,58
0,50	4,48
0,60	4,92



JIS 18-135-1080

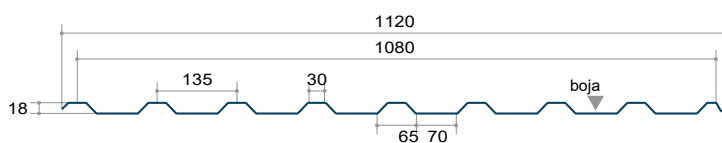

DEBLJINA (mm)	TEŽINA (kg/m ²)
0,35	3,16
0,40	3,58
0,50	4,48
0,60	4,92
0,75	7,12



Jl 18-076-988 (sinus)

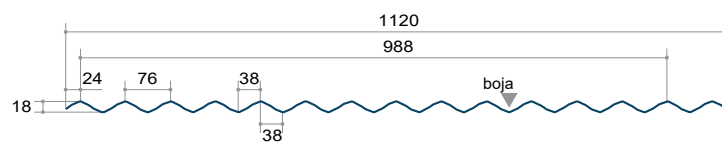

DEBLJINA (mm)	TEŽINA (kg/m ²)
0,40	3,97
0,45	4,46
0,50	4,96
0,60	5,45
0,75	7,14

ZAKRIVLJENI LIM ZID



JIS 35-207-1035

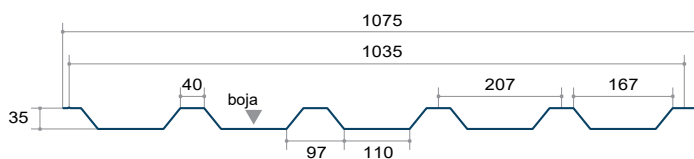

DEBLJINA (mm)	TEŽINA (kg/m ²)
0,35	3,44
0,40	3,81
0,45	4,29
0,50	4,76
0,60	4,92
0,75	7,12



JIS 38-250-1000

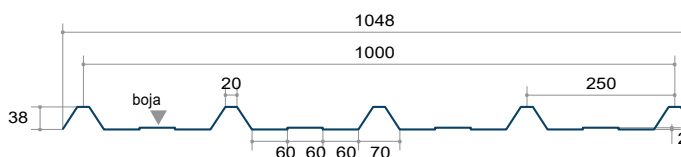

DEBLJINA (mm)	TEŽINA (kg/m ²)
0,35	3,44
0,40	3,94
0,45	4,44
0,50	4,92
0,60	4,92
0,75	7,34



JIS 45-333-1000

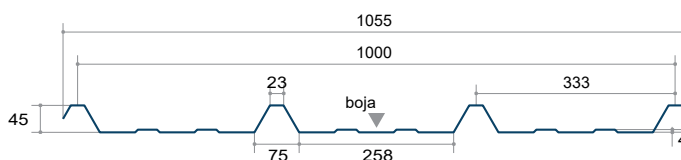

DEBLJINA (mm)	TEŽINA (kg/m ²)
0,35	3,44
0,40	3,94
0,45	4,44
0,50	4,92
0,60	4,92
0,75	7,34

ZAKRIVLJENI LIM

Unutrašnje ploče i zidne obloge



JIS 58-205-820

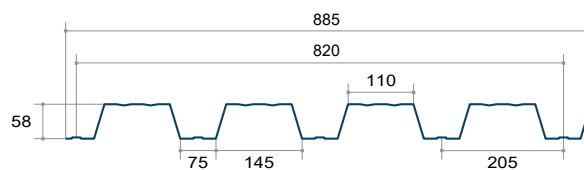

DEBLJINA (mm)	TEŽINA (kg/m ²)
0,75	8,77
1,00	11,28

Koristi se kao trajna oplata samo pocinkovana.

Profil ima utiske na pregibima.

ZAKRIVLJENI LIM OPTIQUE



JIS OPTIQUE

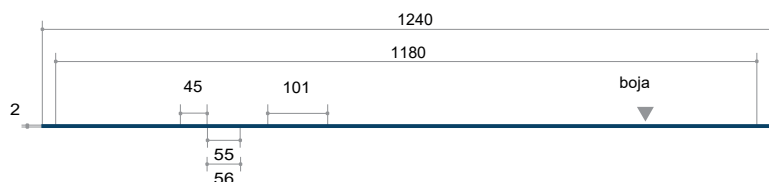

DEBLJINA (mm)	TEŽINA (kg/m ²)
0,35	3,16
0,40	3,58
0,50	4,48
0,60	4,92

VISOKI ZAKRIVLJENI LIM

RAVNI KROVOVI



JIS 85-280-1120

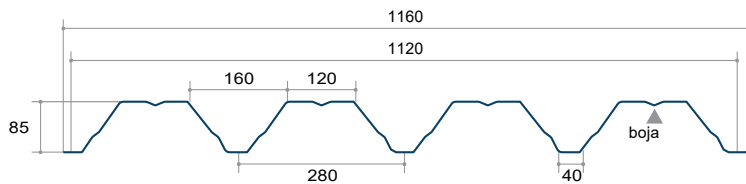

DEBLJINA (mm)	TEŽINA (kg/m ²)
0,75	10,10
0,88	11,83
1,00	13,43
1,25	15,16



JIS 153-280-840

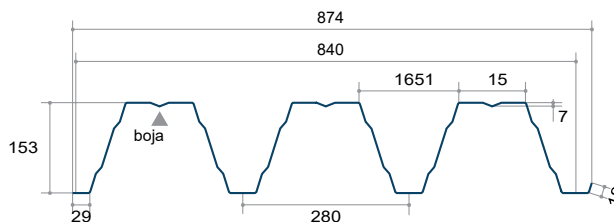

DEBLJINA (mm)	TEŽINA (kg/m ²)
0,75	10,61
0,88	12,43
1,00	14,11
1,25	17,61



JIS 200-420-840

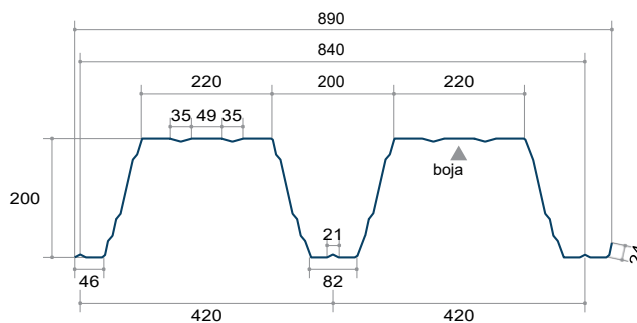

DEBLJINA (mm)	TEŽINA (kg/m ²)
0,75	10,61
0,88	12,43
1,00	14,11
1,25	17,61

ZAKRIVLJENI LIM PLANCHE



JIS PLANCHE

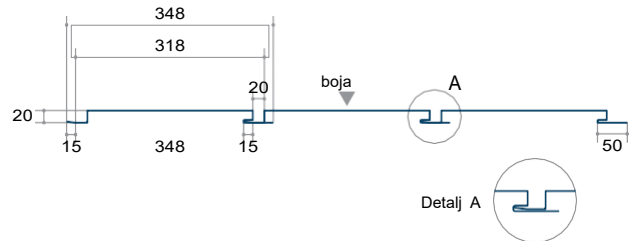

MAKSIMALNA DIMENZIJA
6 m

MONTAŽA

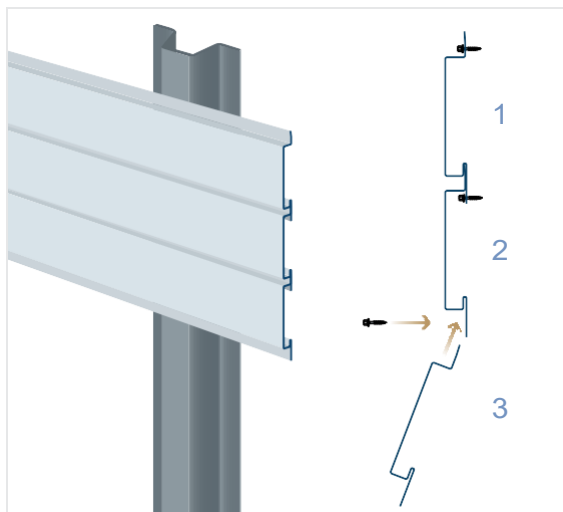

ZAVRŠNA OBRADA PROFILA | SAVITAK PO NARUDŽBI

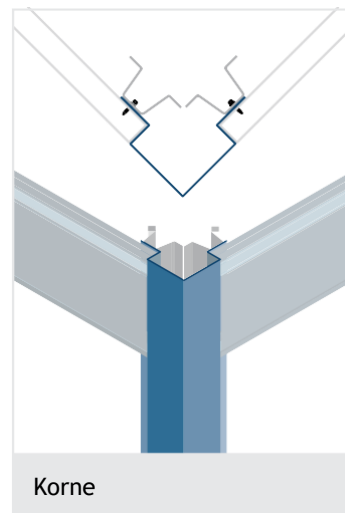
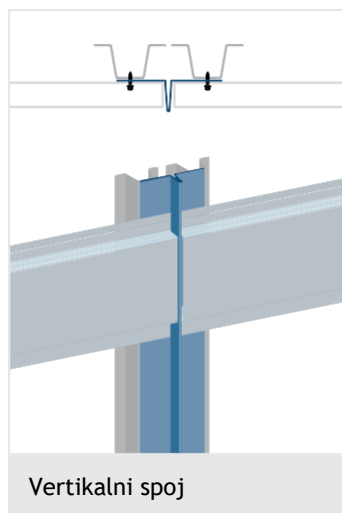
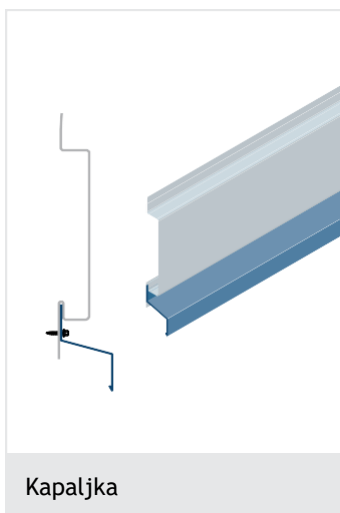

SENDVIČ PANELI KROVNI



4-SLOJNI KROVNI PIR PANEL

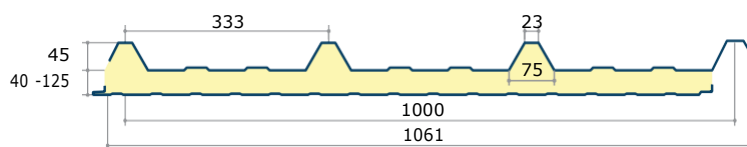

DEBLJINA (mm)	TEŽINA (kg/m ²)	OTPORNOST NA VATRU (min.)
40	9,93	REI 15
50	10,44	REI 20
60	10,72	REI 30
80	11,48	REI 20*
100	12,30	REI 60
125	13,33	REI 45

* Nosivost od 50 kg



PANEL MINERALNA VUNA KROVNI

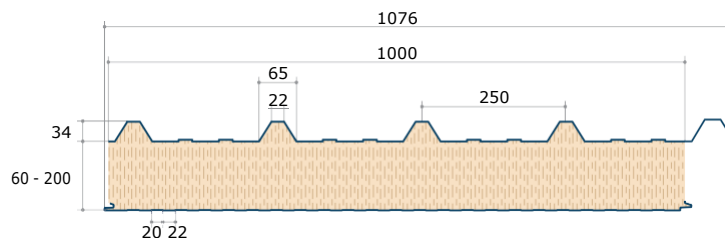

DEBLJINA (mm)	TEŽINA (kg/m ²)	OTPORNOST NA VATRU (min.)
60	16,18	REI 60
80	18,18	REI 60
100	20,18	REI 120
120	22,18	REI 180
150	25,18	REI 180
200	30,18	-



PANEL JIS AGRO ROOF 1000

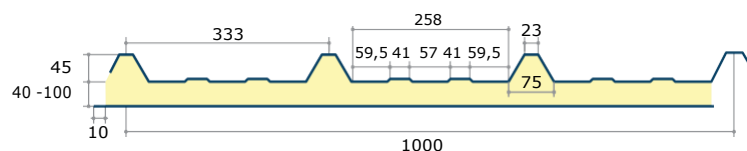

DEBLJINA (mm)	TEŽINA (kg/m ²)
30	7,15
40	7,55
60	8,34
100	10,72

SENDVIČ PANELI ZIDNI



PIR ZIDNI PANEL
SKRIVENO PRIČVRŠČIVANJE

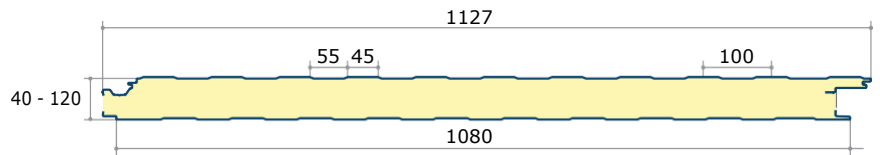

DEBLJINA (mm)	TEŽINA (kg/m ²)	OTPORNOST NA VATRU (min.)
40	9,93	-
50	10,44	-
60	10,72	EI 20
80	11,48	EI 20
100	12,30	EI 30* / EI 60**
120	13,74	EI 30* / EI 60**

* horizontalno / ** vertikalno

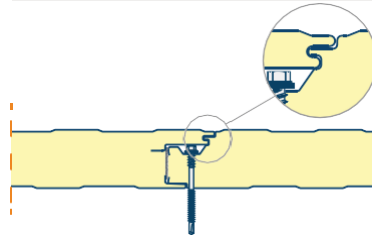

PIR ZIDNI PANEL
VIDLJIVO PRIČVRŠČIVANJE

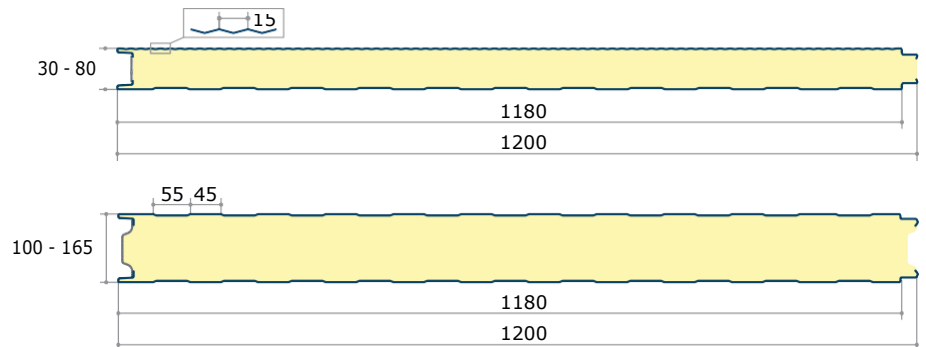

DEBLJINA (mm)	TEŽINA (kg/m ²)	OTPORNOST NA VATRU (min.)
30	9,34	-
40	9,93	EI 15
50	10,44	EI 15
60	10,72	EI 20
80	11,43	EI 20
100	12,30	EI 30
120	13,74	EI 30
150	14,94	EI 30

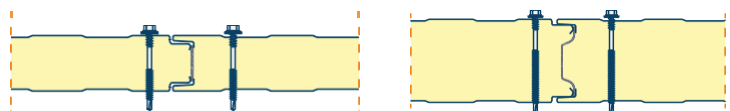

SENDVIČ PANELI ZIDNI

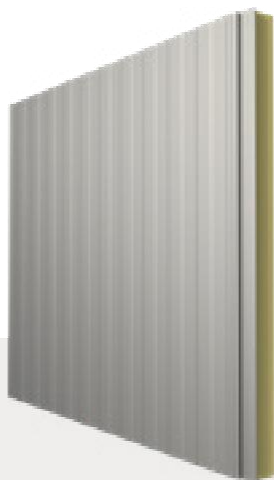

ZIDNI PANEL OD MINERALNE VUNE
SKRIVENO PRIČVRŠČIVANJE

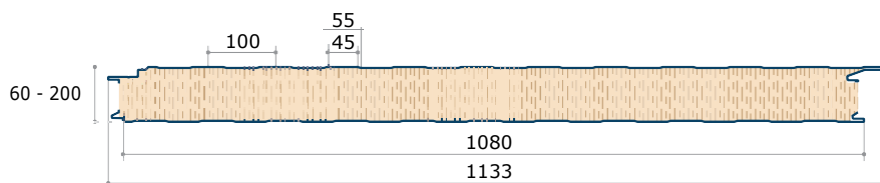

DEBLJINA (mm)	TEŽINA (kg/m ²)	OTPORNOST NA VATRU (min.)
60	17,44	EI 30
80	19,80	EI 45* / EI 60**
100	22,16	EI 45* / EI 60**
120	24,52	EI 120* / EI 60**
150	28,06	EI 180* / EI 60**
180	31,67	EI 180* / EI 60**
200	33,96	EI 180* / EI 60**

*horizontalno / ** vertikalno

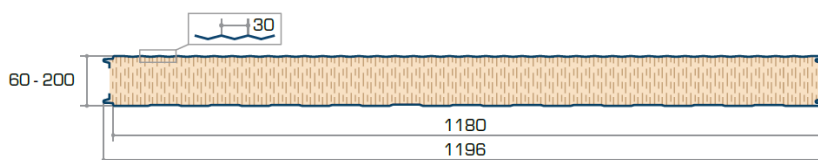

DEBLJINA (mm)	TEŽINA (kg/m ²)	OTPORNOST NA VATRU (min)
60	17,44	EI 30
80	19,80	EI 45* / EI 60**
100	22,16	EI 90* / EI 120**
120	24,52	EI 120* / EI 180**
150	28,06	EI 120* / EI 180**
180	31,67	EI 120* / EI 180**
200	33,96	EI 120* / EI 180**

* horizontalno / ** vertikalno

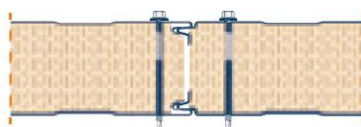

SENDVIČ PANELI MINERALNA VUNA

ZIDNI - dostupni profili



ZIDNI PANEL OD MINERALNE VUNE, SKRIVENO
PRIČVRŠČIVANJE, M-O (mikrooptički)

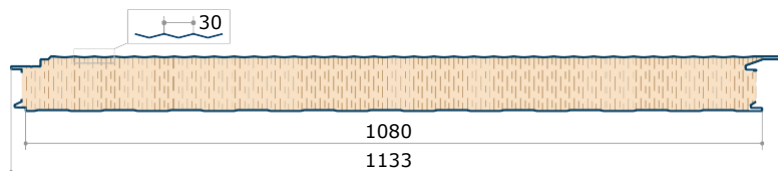

ZIDNI PANEL OD MINERALNE VUNE
SKRIVENO PRIČVRŠČIVANJE L-O (lis-optički)

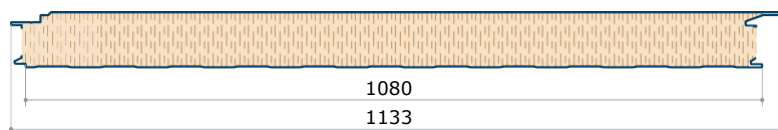

ZIDNI PANEL OD MINERALNE VUNE
SKRIVENO PRIČVRŠČIVANJE O-O (optički-optički)

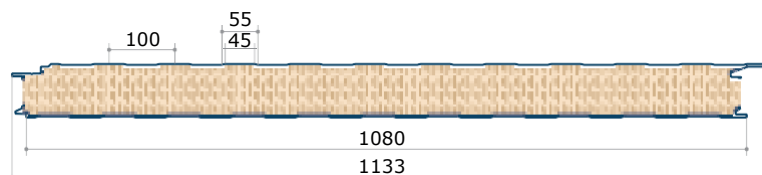

SENDVIČ PANELI MINERALNA VUNA

ZIDNI - dostupni profili



ZIDNI PANEL OD MINERALNE VUNE
SKRIVENO PRIČVRŠČIVANJE O-L (optički-lis)

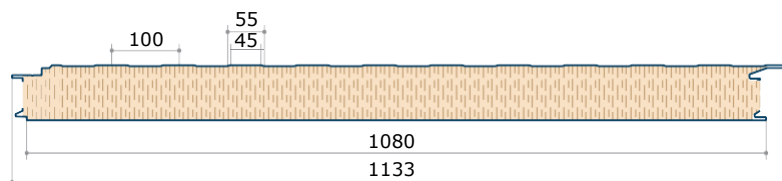

ZIDNI PANEL OD MINERALNE VUNE
SKRIVENO PRIČVRŠČIVANJE M-L (mikro-lis)

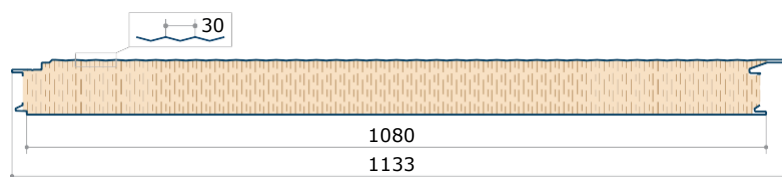

ZIDNI PANEL OD MINERALNE VUNE
SKRIVENO PRIČVRŠČIVANJE L-L (lis-lis)

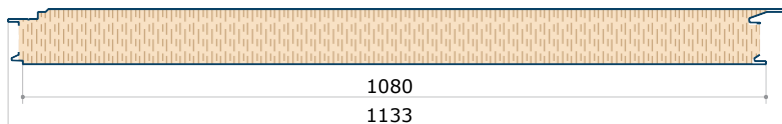

SENDVIČ PANELI MINERALNA VUNA

ZIDNI - dostupni profili



ZIDNI PANEL OD MINERALNE VUNE
SKRIVENO PRIČVRŠČIVANJE M-O (mikrooptički)

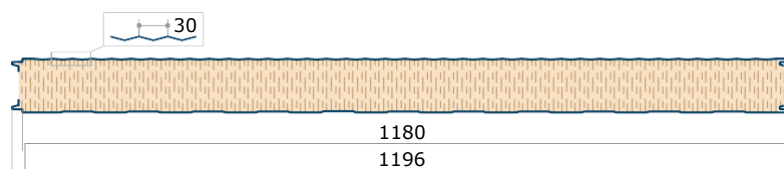

ZIDNI PANEL OD MINERALNE VUNE
VIDLJIVO PRIČVRŠČIVANJE L-O (lis-optički)

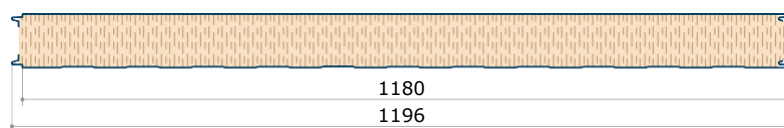

ZIDNI PANEL OD MINERALNE VUNE
VIDLJIVO PRIČVRŠČIVANJE O-O (optički-optički)

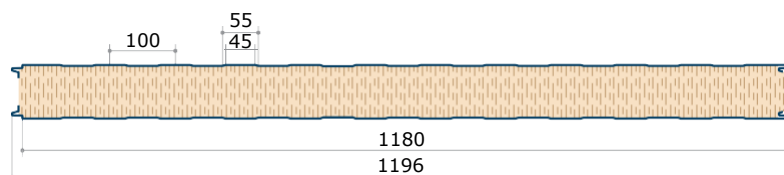

SENDVIČ PANELI MINERALNA VUNA

ZIDNI - dostupni profili



ZIDNI PANEL OD MINERALNE VUNE
VIDLJIVO PRIČVRŠČIVANJE O-L (optički-lis)

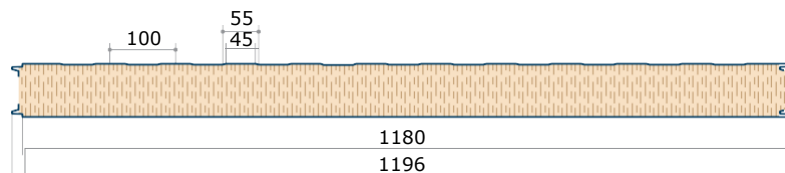

ZIDNI PANEL OD MINERALNE VUNE
VIDLJIVO PRIČVRŠČIVANJE M-L (mikro-lis)

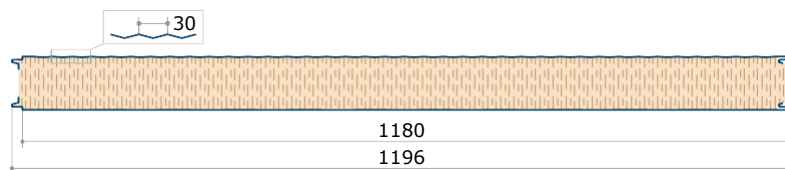

ZIDNI PANEL OD MINERALNE VUNE
VIDLJIVO PRIČVRŠČIVANJE L-L (lis-lis)

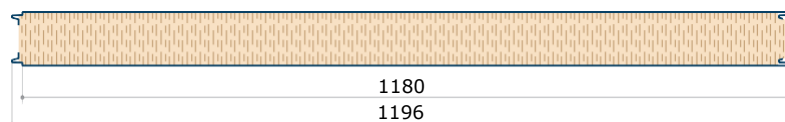

SENDVIČ PANELI PIR

ZIDNI - dostupni profili



PIR ZIDNI PANEL
SKRIVENA FIKSACIJA M-O (mikro-optička)

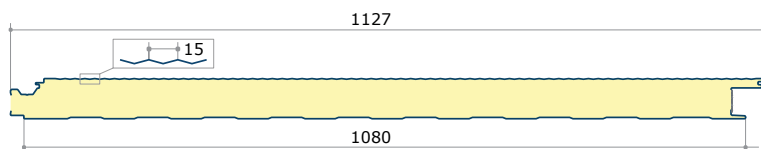

PIR ZIDNI PANEL
SKRIVENO PRIČVRŠĆIVANJE L-O (lis-optički)

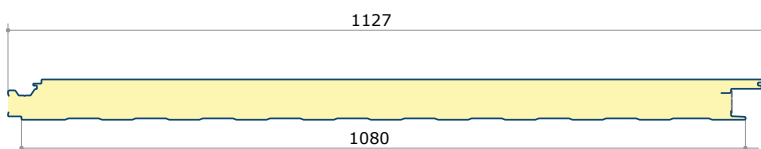

PIR ZIDNI PANEL
SKRIVENO PRIČVRŠĆIVANJE O-O (optički-optički)

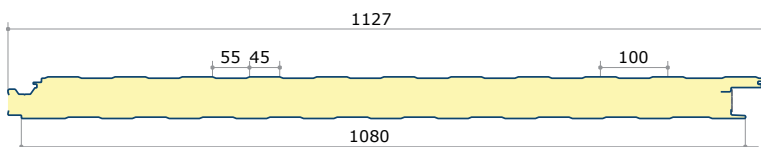

SENDVIČ PANELI PIR

ZIDNI - dostupni profili



PIR ZIDNI PANEL
SKRIVENO PRIČVRŠČIVANJE O-L (optički-lis)

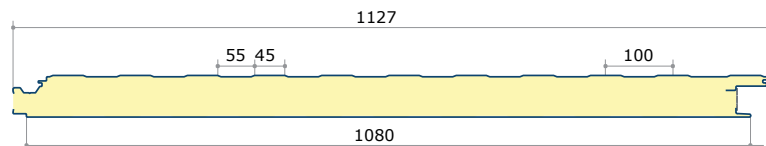

PIR ZIDNI PANEL
SKRIVENO PRIČVRŠČIVANJE M-L (mikro-lis)

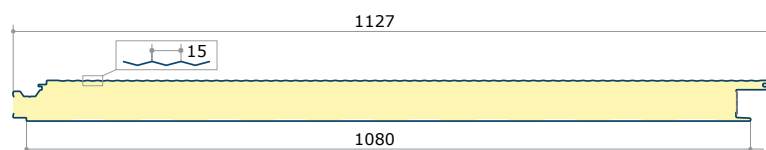

PIR ZIDNI PANEL
SKRINO PRIČVRŠČIVANJE L-L (lis-lis)

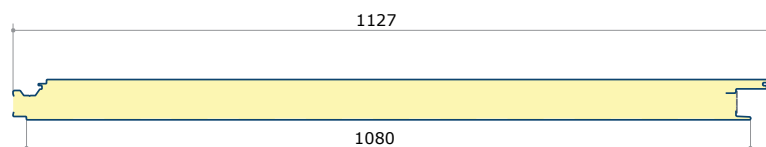

SENDVIČ PANELI PIR

ZIDNI - dostupni profili



PIR ZIDNI PANEL
VIDLJIVO PRIČVRŠČIVANJE M-O (mikro-optički)

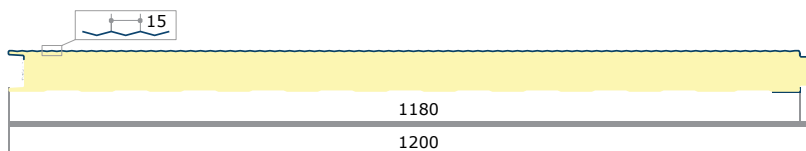

PIR ZIDNI PANEL
VIDLJIVO PRIČVRŠČIVANJE L-O (lis-optički)

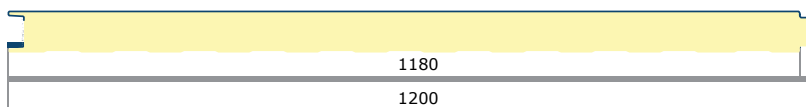

PIR ZIDNI PANEL
VIDLJIVO PRIČVRŠČIVANJE O-O (optičko-optičko)

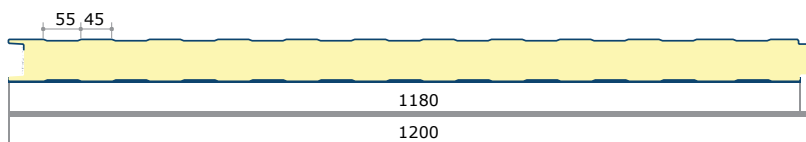

SENDVIČ PANELI PIR

ZIDNI - dostupni profili

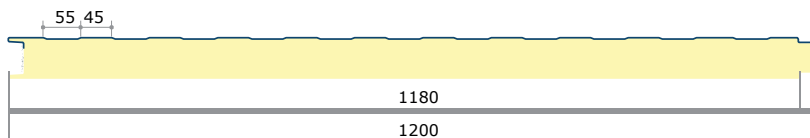

PIR ZIDNI PANEL
VIDLJIVO PRIČVRŠĆIVANJE O-L (optički-
k

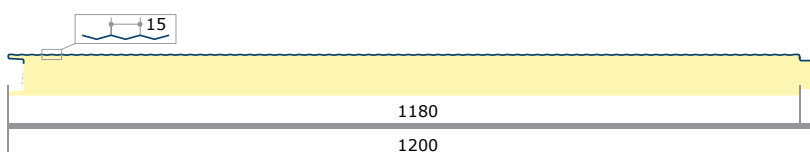

PIR ZIDNI PANEL
VIDLJIVO PRIČVRŠĆIVANJE M-L (mikro-lis)

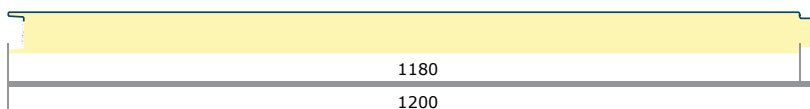

PIR ZIDNI PANEL
VIDLJIVO PRIČVRŠĆIVANJE L-L (lis-lis)

DODATNA OPREMA

Pribor za zaptivanje i izolaciju



IZOBUTIL LEPLJIVA TRAKA
(15 mm x 60 ml)



ZAPTIVAČ RUKAVA
D60 mm - D475 mm



SILIKON
AQUAFIX



SAMOLEPLJIVI ZAPTIVNI
SUNĐER (ŽLEB)

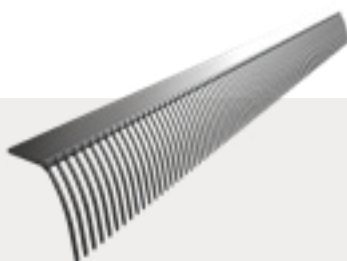

PLASTIČNI ŠILJCI
ZA PTICE



BOJA ZA
RETUŠIRANJE



ALUMINIJUMSKA FOLIJA
(100 mm / 150 mm / 300 mm x 10 ml)



IZOLEN
ZAPTIVNA ROLA ZA DIMNJAK

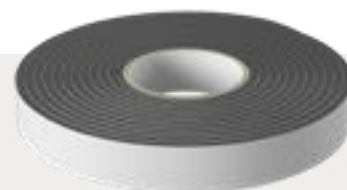

EKSPANZIVNA IZOLACIONA TRAKA
(30 X 8/4 MM)

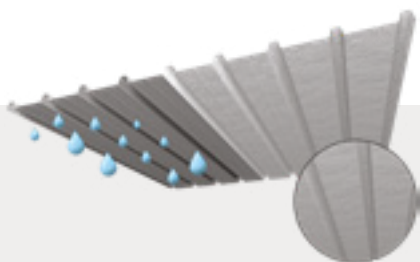

DRIPOSTOP
MEMBRANA

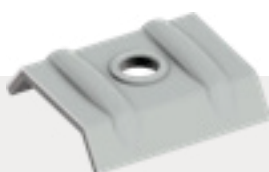

KAPA ZA
UČVRŠĆIVANJE

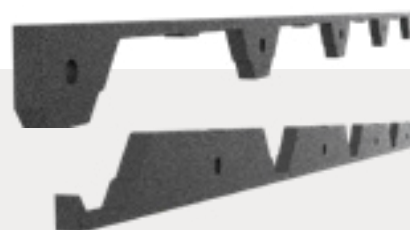

ZAPTIVNE
TRAKE

DODATNA OPREMA transparentne ploče

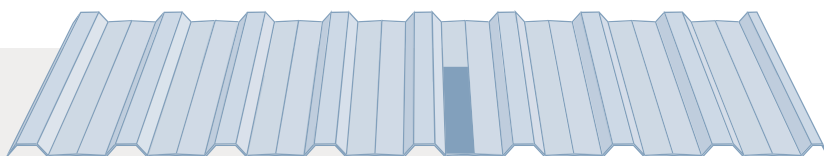

16,5-137,5-1100

Poliester 450 g/m²
Dužina: 6 m

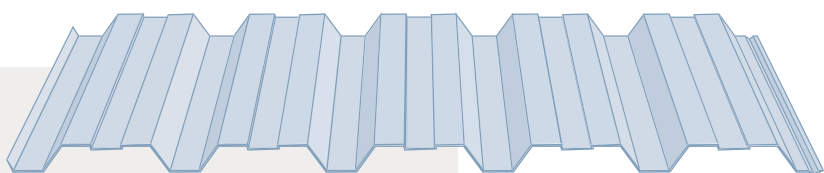

35-207-1035

Poliester 450 g/m²
Dužina: 6 m

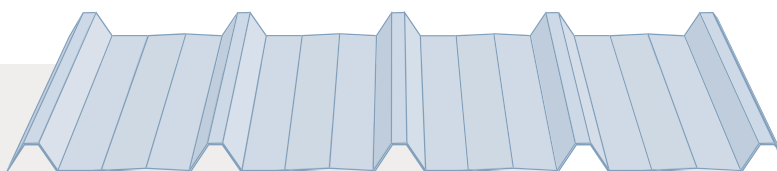

38-250-1000

Poliester 450 g/m²
Dužina: 6 m

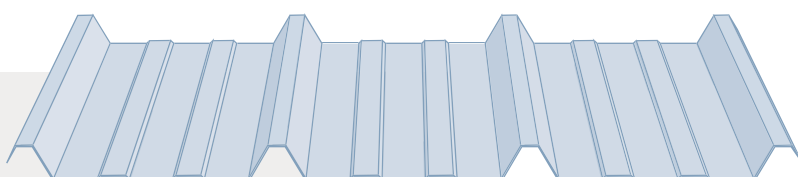

45-333-1000

Poliester 450 g/m²
Dužina: 6 m

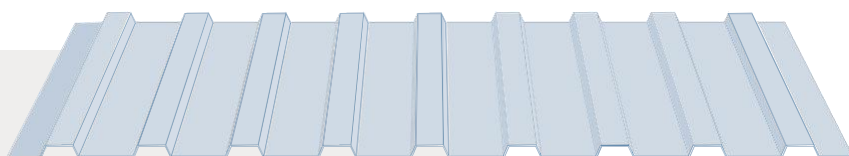

GRECA

Poliester 600 g/m²
Dužina: 6 m | 7,6 m

DODATNA OPREMA
završna obrada metala



DVOSTRUKO NAKOŠENI OBOČ

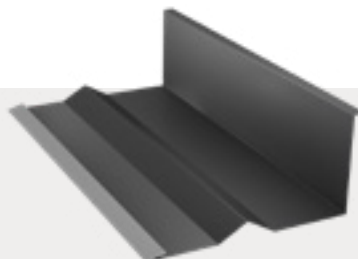

KUK RAVAN



RAVNI MALI SLEMEN

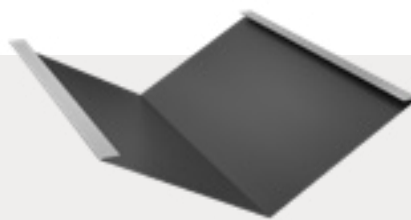

OLUK

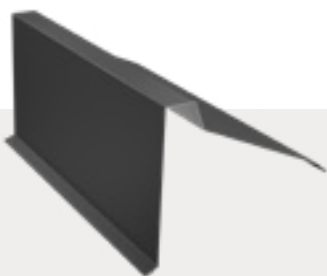

SLEMENSKA KAPA



ZABATNI RUB (VIJATROVNICA)

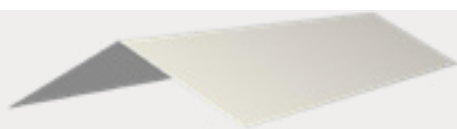

PODSLEMEN

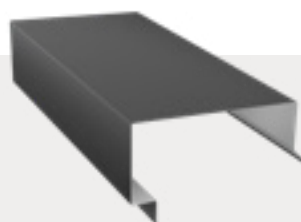

POTKROVNA PREGAČA

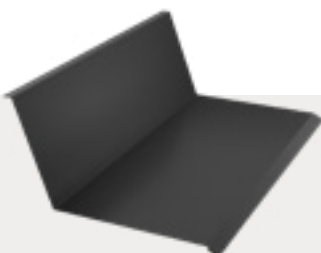

KUK



SNEGOBRAN

DODATNA OPREMA
završna obrada metala

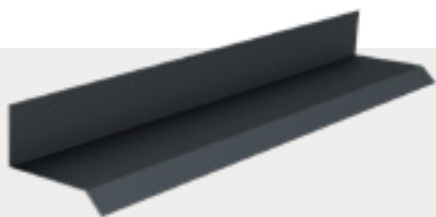

POSTOLJE

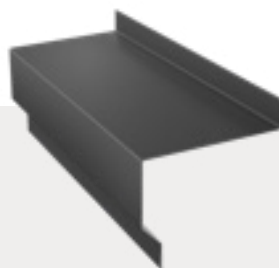

PROFIL ZA RUBOVE PROZORA



SPOLJNI UGAO



PROFIL ZA RUBOVE PROZORA

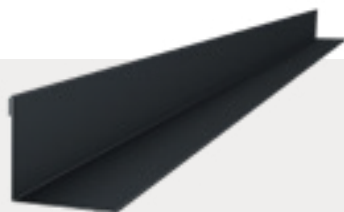

UNUTARNJI UGAO

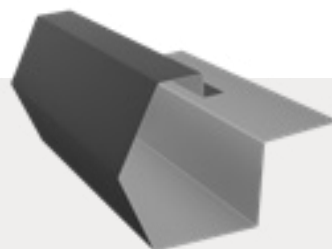

METALNI ODVOD

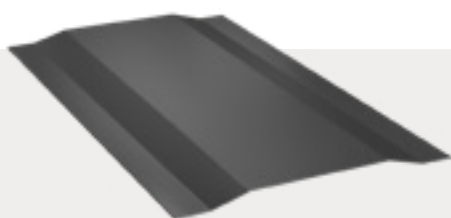

PROFIL ROST

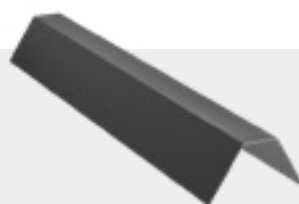

PROFIL ZA PRIČVRŠĆIVANJE OLUKA

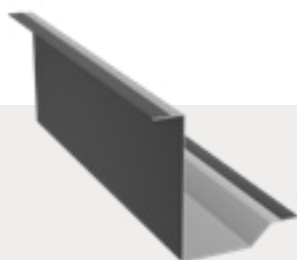

PROFIL ZA OBRUBE PROZORA

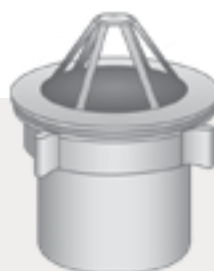

DODATAK ZA SPREČAVANJE ZAČEPLJENJA CEVI

Po zahtevu možemo raditi i druge elemente .
Više detalja možete dobiti od predstavnika JORIS IDE ROMANIA..

ELEMENTI

kišni sistem

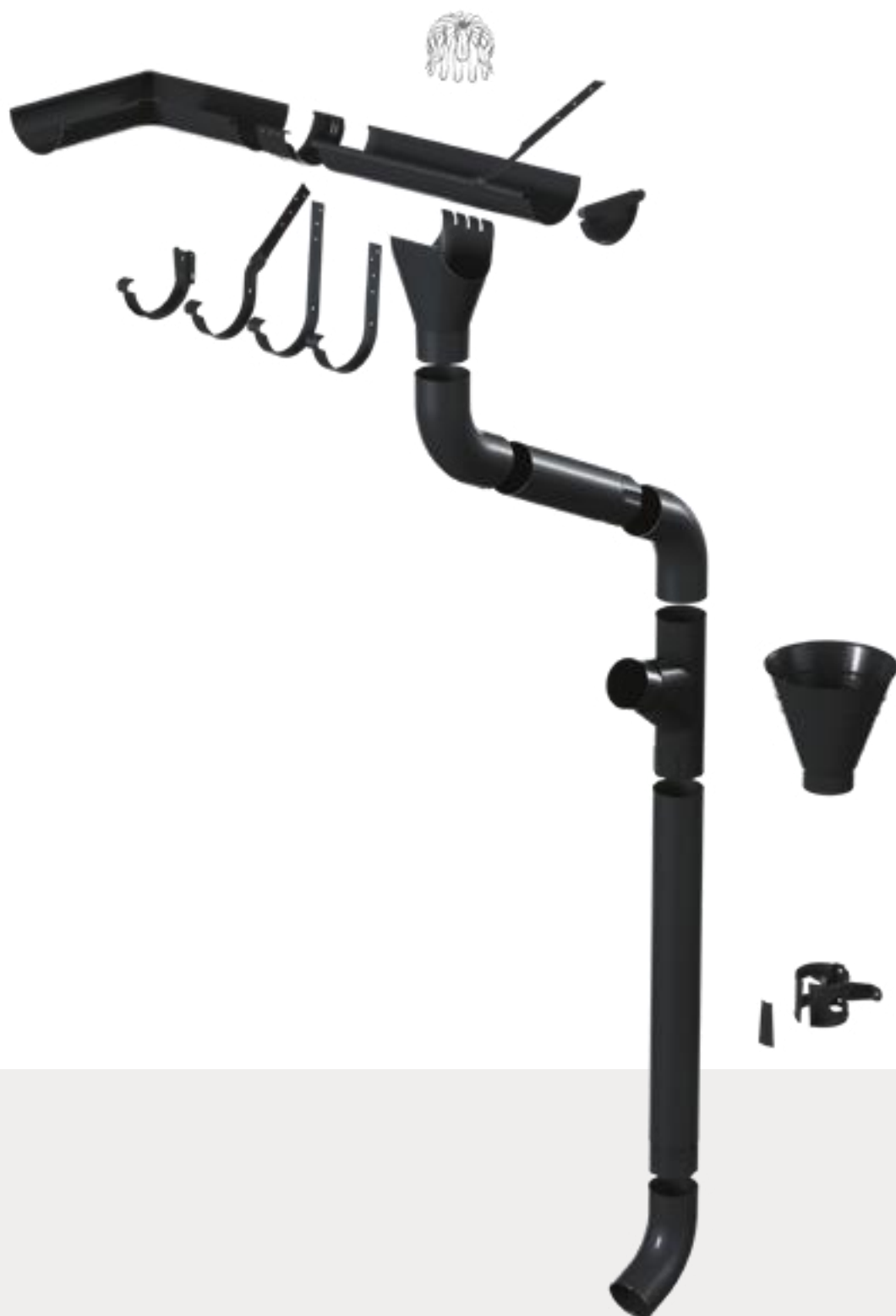

A Pribor i elementi za kompletne sisteme
za odvodnjavanje kišnice.

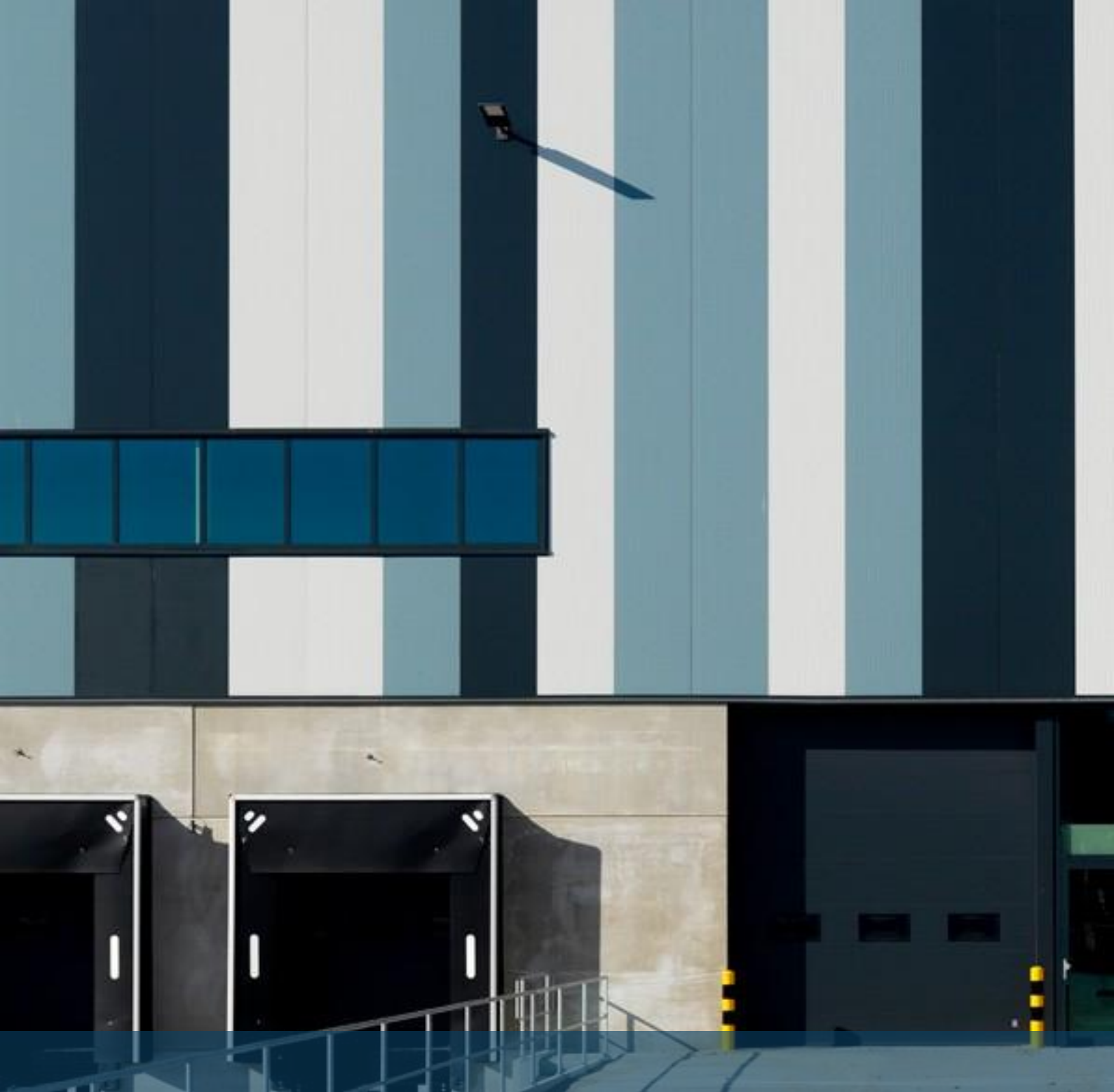

Da biste bili sigurni da koristite najnoviju verziju, preporučujemo vam da je preuzmete sa naše veb stranice: <https://www.jorisode.ro/downloads> ili skeniranjem ovog QR koda.

Ovaj dokument ne daje nikakva prava i podložan je promenama. Zadržavamo pravo da promenimo dokument bez prethodne najave kako bismo odražavali napredak ili poboljšanja.

JORIS IDE SRL

Str. Milano nr. 15, Buftea, județul Ilfov
Str. Principală nr. 58, Buziaș, județul Timiș
Telefon: 0256 307 700

03-2026-v4